

 MAKE IN INDIA



Manufacturer & Importer of Dental Materials & Equipment

Product Catalog 2026



Class I



MFG/MD/2023/000109
MFG/MD/2023/000100



Prime-Dental.in

+91 9503289380

info@prime-dental.in

About us



Company Overview:

Founded in 1987 by Mr. Bharat Thakkar and Dr. Paresh Thakkar, Prime Dental Products Pvt. Ltd. has grown from a dental trading enterprise into one of India's trusted manufacturers and importers of premium dental medical devices.

Prime Dental operates from a world-class, ISO 13485:2016 certified manufacturing facility spread across 13,000 sq. ft. in MIDC Wagle Estate, one of Western India's leading industrial hubs.

With a strong reputation for quality, innovation, and reliability, we serve the dental fraternity across India through an extensive dealer network. Our range of dental products is also exported internationally through valued global trade partners.

Committed to advancing dentistry through superior products and long-term partnerships, Prime Dental continues to strengthen its legacy under the leadership of the next generation, Mr. Tanay Thakkar and Mr. Jay Thakkar, who have been actively driving the company's growth and vision for over a decade.

Dental Materials - 'Make in India' initiative:

We are committed to serve the dental community offering globally acceptable quality products at competitive prices and timely delivery.

Our product range include;

- **Endodontic materials:** MTA Bioceramic Sealer, RC Help (EDTA Gel), RC Cal (Calcium hydroxide in ready to use paste form for temporary RC filling), RC Seal (Epoxy Bonded RC Sealant).
- **Prosthodontic materials:** Prime Chrome (Chromatic alginate impression material), Retra Gel (Retraction Gel) & the foremost manufacturer of Addition silicone impression material (Ad Sil Acura), Bite Registration Putty.
- **Conservative materials:** Restorite Etching Gel (37% orthophosphoric acid gel), TMP-RS (Ready to use temporary filling putty material), Dent Wash (Liquid EDTA).
- **Finishing materials:** Aster prophyl (pumice based prophylaxis paste) and Aster Compo (Alumina based composite polishing paste).
- **Composites:** Restorite range of Composites offers first in class physical properties viz. Bulk Fill, Flow Viscous, Pit & Fissure Sealant, Micro Hybrid Composite, Nano Hybrid, Core Build-up, Restorite Bond 5G (Total etch), Restorite Bond 7G (Self etch).

Import & Distribution:

Since 1991, Prime Dental is representing many renowned international brands in India.

Dental Equipment:

Since 2007, We are dealing in the finest quality of fully programmable electrical Dental chairs & heavy/light Suctions. We have various models of diverse range to cater all your requirements. We specialize in new clinic setup & up-gradation with robust after-sale service.

OBL Products:

Prime Products: Prime X-Ray Film, Prime Cord (Knitted Retraction cord), Prime Disposables (Gloves, Face Mask, Saliva Ejectors).

Allure: Airtors.

Achievements:

Best Dental Manufacturer - Make in India
at 1st National Oral Healthcare Sushruta Awards
hosted by Indian Dental Association (IDA) Foundation
at the hands of Honourable Former President of India,
Dr. A. P. J. Abdul Kalam

Manufactured Products

Page

For Irrigation

01

Prime Chlorhexidine 2% 500ml 2026 Launch

RC Twents 10Pcs (30 Gauge)

Sodium Hypochlorite 3% 500ml

Sodium Hypochlorite 5.25% 500ml

EDTA

01

RC Help 3g / 20g

Dent Wash 30ml

Related Product

Citra Wash 30ml

Calcium Hydroxide

02

BioTemp 3g

RC Cal 2g

RC Cal-I 2g (with Iodoform)

RC Pex 3g (with Iodoform)

Restorite Cal 2g (Light Cured & Rigid Setting)

Temporary Filling **Calcium Hydroxide Powder**

Temporary Filling Material

02

Temporary Filling **Eugenol Liquid** 15ml

Temporary Filling **Eugenol Liquid** 110ml

Temporary Filling **Zinc Oxide Powder** 100g

TMP-RS 40g **Eugenol Free**

Zinc Oxide Eugenol Cement Quick Set

Polymer Reinforce (**IRM**) 15g + 10ml

Root Canal Sealers

03

Prime MTA Bioceramic Root Canal Sealer 3g

RC Fill 15g Powd + 10ml Liq + 5g Acc

RC Fill-I 15g Powd + 10ml Liq + 5g Acc (with Iodoform)

RC Seal 10g Powd & 10ml Liq

RC Seal Plus (12g Liq + 3.5 Liq)

Root Repair Material

03

Prime MTA BioPutty 2g

Prime MTA Packable 1g Powd + 5ml Liq

Solvents of Obturation Material

Page

04

RC Soft 15ml

RC Solve 15ml

Root Canal Disinfectant

04

Primecresol 15ml

Prime CMCP 15ml 2026 Launch

Prime DeVitex (3g) - Devitalizing Paste 2026 Launch

Root Surface Planning

04

Root Help Gel (3g) - 24% EDTA 2026 Launch

Root Help Liquid (15ml) - 15% Citric Acid 2026 Launch

Hemostat & Tissue Management

05

Dent Retract 30ml

Retra Gel 3ml (**Hemostat Gel**)

Retra Liquid 30ml (**Hemostat Liquid**)

A-Silicone (Ad Sil Acura)

06

Bite Registration Putty 2 x 100ml

Putty - Hard Set 800g (Base + Catalyst)

Putty - Soft Set 800g (Base + Catalyst)

Light Cartridge 2 x 50ml (with Tips)

Light Tubes 2 x 25ml

Alginate

05

Algingum 500g

Prime Chrome 450g

Related Product

Clean Tray 250g

Impression Material

06-07

Green Stick 10 Sticks (Approx 90g)

Image 125g Base & 85g Catalyst

Impression Composition 5 Cakes (Approx 200g)

Temporary Luting

07

Templute 50g Base & 15g Catalyst

Manufactured Products

Page

Page

Glass Ionomer Cement (GIC) 07

Prime Cem Ceramic Reinforced

15g Powd+10ml Liq GIC

Prime Cem Luting Type 1

15g Powd+10ml Liq GIC

Prime Cem Restorative Type 2

15g Powd+10ml Liq GIC

Restorite Ionomer Flow (2g) - LC GIC **2026 Launch**

Etchant 08

Etching Gel 3ml / 2 x 25ml (Blue colour - Flowable)

Restorite Etching Gel 3ml / 2 x 25ml (Purple

colour - Thixotropic)

Etching Liquid 15ml

Bonding Agent 08

Restorite Bond 5G 5ml

Restorite Bond 7G 5ml

Flowable Composite 09

PurpleSeal - Purple Colour Composite 2g

Restorite Bulk Fill (Flowable) 2g

Restorite Bulk Fill Kit (Flowable) 2g x 4

Restorite Flow Viscous 2g

Restorite Flow Viscous Kit 2g x 4

Restorite Ionomer Flow (2g) - LC GIC **2026 Launch**

Restorite Pit & Fissure Sealant 2g

Packable Composite 10

BiteRise (4g) - Blue Colour Composite **2026 Launch**

Restorite Bulk Fill (Packable) 4g

Restorite Bulk Fill Kit (Packable) 4g x 7

Restorite Core Build-up Translucent 4g (6mm depth of cure)

Restorite Micro Hybrid 4g

Restorite Micro Hybrid Kit 4g x 7

Restorite Nano Hybrid 4g

Restorite Nano Hybrid Kit 4g x 7

Liquid Resin 11

Restorite Cavo Surface Sealer 5ml

Restorite Modelling Resin 5ml

Orthodontic Material 11

BiteRise (4g) - Blue Colour Composite **2026 Launch**

Restorite OrthoGrip Composite 5g

Restorite OrthoGrip Primer 5ml

Restorite OrthoGrip Composite Kit

Gingival Barrier 12

GingiSafe 1.2ml

GingiSafe Kit 1.2ml x 4

Bleaching System 12

LilyBright **2026 Launch**

Desensitisers 12

Desensitiser 3g

Restorite Desensitiser 5ml

Prophylaxis & Polishing System 12-13

Aster Compo 4g

Aster Prophy 45g

(Lemon/Orange/Strawberry/Mint)

Aster Prophy 4 x 45g (Assorted Flavours)

Miscellaneous 13

BioFilmX 500ml

Caries Indicator 15ml

Debubbler 100ml Spray / 500ml Refill Jar

Dent Dry 30ml

NT Fog 100ml

Prime Instrument Rust Remover 500ml **2026 Launch**

Prosthoclean 5ml **2026 Launch**

For Irrigation

Prime Chlorhexidine

2026 Launch

2%



2% Chlorhexidine Digluconate Solution for Effective Irrigation during Endodontic Procedures

- I  Open cap Remove aluminium seal
- II  Puncture syringe adaptor with needle on three sides (Do not puncture centre part first)
- III  Puncture syringe adaptor from centre hole with needle (Straight puncture is recommended)
- IV  Engage the syringe firmly on syringe adaptor and start pulling syringe piston

Available Packing : 500ml Bottle in 2%

RC Twents



Irrigation Needle

- Irrigation needle with two side vents.
- Side vent avoids irrigation fluid to be pushed apically.



Available Packing : 10pcs in a pack





Sodium Hypochlorite

For Root Canal Irrigation



3%

- Available in 3% & 5.25 strength
- Mint aroma
- With pH buffer
- Can digest pulpal debris

- I  Open cap Remove aluminium seal
- II  Puncture syringe adaptor with needle on three sides (Do not puncture centre part first)
- III  Puncture syringe adaptor from centre hole with needle (Straight puncture is recommended)
- IV  Engage the syringe firmly on syringe adaptor and start pulling syringe piston



5.25%

Available Packing : 500ml Bottle in 3% & 5.25 strength

EDTA

RC Help

Lubricating Paste for RC Biomech.



- EDTA paste.
- Contains carbamide peroxide.
- Increases RCT instrument's life.
- Gentle O₂ release while irrigating with NaOCl.
- Cleanses canal

Available Packing • **Regular Pack** : 3g syringe & 5 application needles
 • **Big Pack** : 20g big syringe, 25 application needles, 1 contactor & 3g empty syringe

Dent Wash

Aqueous EDTA



- 17% EDTA
- For smear layer removal.
- Use before bonding of dentin.
- Use before root canal sealant.

Available Packing : 30ml Bottle

Related Product

Citra Wash



20% Citric Acid Solution

- Cleansing/conditioning of prepared canals, and
- Dissolving/cleaning residues of calcium hydroxide
- Removing smear layer

Available Packing : 30ml Bottle

Calcium Hydroxide

BioTemp



Easy & Ready-to-Use Bioceramic Intra Canal Temporary Filling Material

- Radiopaque
- Intracanal dressing material
- Non-setting, ready-to-use paste
- Contains silicates for gradual release of calcium ions
- Can be left in the root canal for up to 3 weeks
- Easy to remove
- Recommended for use in cases of perforation & resorption prior to Prime's MTA Putty, TA Packable & MTA Bioceramic Sealer

Available Packing : 3g Syringe & 5 Capillary Tips

RC Cal-I



With Iodoform

Ready to Use Paste. Intracanal Temporary Filling

- Contains barium sulphate. Radio opaque.
- Highly alkaline Ca(OH)₂ paste.
- Can be easily removed by reamers.
- Non drying paste.

Available Packing • 2g syringe & 5 application needles

Restorite Cal



Light cured Calcium Hydroxide Cavity Base/Liner

- Easy to use, light curable, one component system
- Used for direct and indirect pulp capping
- Used as cavity liner under filling material
- Low solubility

Available Packing : 2g syringe

RC Cal



Without Iodoform

Ready to Use Paste. Intracanal Temporary Filling

- Contains barium sulphate. Radio opaque.
- Highly alkaline Ca(OH)₂ paste.
- Can be easily removed by reamers.
- Non drying paste.

Available Packing • 2g syringe & 5 application needles

RC Pex



- Highly radiopaque calcium hydroxide paste with iodoform.
- Capillary tips for easy dispensing.

Available Packing • 3g syringe & 5 Capillary Tips

Temporary Filling Calcium Hydroxide Powder



Powder For Dental Cement For Cavity Base

- It can be used for pulp capping. Need to mix with water for injection to make paste of desired consistency while using

Available Packing : 10g Bottle

Temporary Filling Material

Temporary Filling Eugenol Liquid



- Used with zinc oxide powder for temporary filling.

Available Packing : 15ml Bottle / 110ml Bottle

TMP-RS



Temporary Filling Material

- Eugenol Free
- Temporary filling for cavities.
- Sets with moisture.
- Easy to place and remove.
- Two wads to offer maximum protection from moisture.

Available Packing : 40g Bottle

Temporary Filling Zinc Oxide Powder



- Used with eugenol liquid for temporary filling material.

Available Packing : 100g Bottle

Zinc Oxide Eugenol Cement Quick Set Polymer Reinforced (Intermediate Restorative Material)



Available Packing : 15g Powder / 10ml Liquid

Root Canal Sealers

Prime MTA Bioceramic Root Canal Sealer



- Ready-to-Use Paste.
- Premixed, Easy-to-Use.
- Radiopaque
- Bioactive & Biocompatible
- Hydrophilic

Available Packing : 3g Paste & 15 Capillary Tips



Available Packing : 15g Powder, 10ml Liquid & 5g accelerator

RC Fill
Without Iodoform

RC Fill-I
With Iodoform

Root Canal Sealant & Filling
 Contains Calcium Hydroxide, Zinc oxide & Eugenol.
 Radio opaque.
 Bioresorbable set mass.



Available Packing : 15g Powder, 10ml Liquid & 5g accelerator

RC Seal



Epoxy Bonded Root Canal Sealant

- Root canal sealant.
- Epoxy bonded.
- Virtually formaldehyde free.
- Shrink free set.
- Eugenol free.
- Shall not retard composite setting.
- Non Bio Resorbable.

Available Packing : 10g Powder & 10ml Liquid
 ● 10ml refill liquid also available separately

RC Seal Plus



Epoxy Bonded Root Canal Sealant

- Hexamine free Epoxy bonded root canal sealant.
- Easy to mix paste-paste system in a two-barrel syringe.
- High radio opacity.
- Long term sealing properties.
- Good dimensional stability.

Available Packing : 1 x 15.5g Dual syringe

Root Repair Material

Prime MTA BioPutty

Ready-to-Use Bioceramic Putty for Root Repair

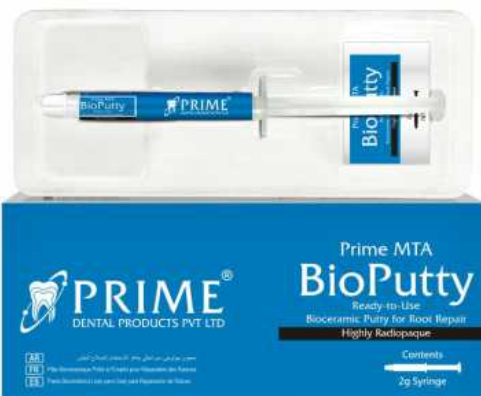

- Putty Consistency
- Non-Staining
- Highly Radiopaque

Available Packing : 2g Syringe

Prime MTA Packable

MTA Packable can be used for Apexification, Repairing root perforations, Internal root resorption and Pulp capping.



Available Packing : 1g Powder & 5ml Liquid

Solvents of Obturation Material

RC Soft

Softens Resin Based Cements



- Softening agent for epoxy resin based root canal sealants.

Available Packing : 15ml bottle

RC Solve

GP & ZnOE Solvant



- Softens GP points.
- Softens zinc oxide cement.
- Controlled penetration to avoid disturbing apical seal.
- Shall not retard composite setting.

Available Packing : 15ml bottle

Root Canal Disinfectant

Primecresol



Formocresol

Available Packing : 15ml Bottle

Prime CMCP

2026 Launch



Camphorated Parachlorophenol

- Disinfectant Antimicrobial Agent for Root Canal
- Corticosteroid-Free
- Antiseptic Action by Camphor
- Bactericidal Action by Para-Chlorophenol
- For Professional Use Only

Available Packing : 15ml Bottle

Prime DeVitex

2026 Launch



Pulp Devitalising Paste. Arsenic Free.

- Bright Red to Easily Identify
- For Pulp Necrosis & Devitalization
- Fast-Acting

Available Packing • 3g syringe

Root Surface Planning

Root Help Gel

2026 Launch

24% EDTA
For Bio Root Planning

- Chelating Agent during Root Planning
- Removes Smear Layer, Exposes Collagen for Improved Periodontal Ligament Cell Adhesion



Available Packing • 3g syringe

Root Help Liquid

2026 Launch

15% Citric Acid
Root Planning Liquid

- Disinfectant Antimicrobial Agent for Root Canal
- Corticosteroid-Free
- Antiseptic Action by Camphor
- Bactericidal Action by Para-Chlorophenol
- For Professional Use Only



Available Packing : 15ml Bottle

Hemostat & Tissue Management

Dent Retract



Aqueous Ferric Chloride

- Helps in retraction of gingival.
- Does not retard the rubber base.

Available Packing : 30ml Bottle

Retra Gel

25% Aluminum Chloride Gel



- Retra Gel is a 25% Aluminum Chloride aqueous viscous gel.
- No residue or stain making it ideal for use in the esthetic zone.
- The solutions facilitate the insertion of the cord into the sulcus



Available Packing : 3ml Syringe & 5 application needles

Retra Liquid

25% Aluminium Chloride Aqueous Astringent Solution



- For chemical retraction of gingival margin
- Clear transparent solution
- Non-staining
- Use along with Prime Retraction Cord
- Wash after use before final impression

Available Packing : 30ml Bottle

Alginate



Alginum CE
 Non Chromatic



Available Packing : 500g pouch

Prime Chrome CE
 Chromatic

Thixotropic
 Rubber effect
 Dust free
 Easy mix formula
 Stable for 50 hours under humidity



Available Packing : 450g Pouch



Related Product

Clean Tray CE



Alginate and Plaster Residue Cleaner

- 250g powder for 2.5 litre solution.
- Biodegradable powder.
- Can clean up to 125 trays.

Available Packing : 250g Powder

A-Silicone (Ad Sil Acura)

Ad-Sil Acura Bite Registration Putty



- No Heating required
- Addition Silicone based Bite Registration Putty
- Shore A - 87
- Easy-to-Use
- Can be used for indexing
- No wastage compared to Bite Registration in Cartridge form

Available Packing : 100ml Base & 100ml Catalyst

Hard Set



Shore A - 80



- Addition silicone impression material.
- Accurate detailed reproduction.
- Highly stable impression.
- Compatible to all dye materials.
- Suitable for all impression technique.
- Ideal choice of impression for multiple pouring.

Available Packing : 400g Base & 400g Catalyst

Ad-Sil Acura Light Cartridge



Polyvinyl Siloxane Impression Material

- Shore A-65.
- Light body available in dual chamber cartridge.
- Hydrophilic nature.
- Can be used with any other addition silicone putty.

Available Packing : Cartridge 2 x 50ml (Base & Catalyst) with Tips

Soft Set



Shore A - 60

Available Packing : 400g Base & 400g Catalyst

Ad-Sil Acura Light Tubes



Polyvinyl siloxane impression material

- Shore A-65.
- Addition silicone impression material.
- Accurate detailed reproduction.
- Highly stable impression.
- Compatible to all dye materials.
- Suitable for all impression technique.
- Ideal choice of impression for multiple pouring.

Available Packing : Tubes 25ml Base & 25ml Catalyst

Impression Material

Image



Impression Paste for Edentulous Cases

- Zinc oxide base.
- Eugenol free.
- No irritation to lip & mucosa.

Available Packing : 125g Base & 85g Catalyst

Green Stick CE

Tracing Sticks



- Low fusing compound.
- Soft green tracing sticks.
- For border moulding work.

Available Packing : 10 Sticks in a pack (90g)

Impression Composition CE

For Accurate Edentulous Impressions



- High fusing compound.
- Functional impression compound.
- Accurate impression.
- Suitable for primary impression of complete denture prosthesis.

Available Packing : 5 cakes in a pack (200g)

Temporary Luting

Templute

Temporary Luting for C & B



- Two paste system.
- Eugenol free.
- Shall not retard any bonding agent.
- C & B can be removed easily.

Available Packing : 50g Base & 15g Catalyst

Glass Ionomer Cement (GIC)

Prime Cem Luting

Glass Ionomer Cement



Available Packing : 15g Powder, 10ml Liquid, Scoop/Spatula & Mixing Pad

Prime Cem Restorative

Glass Ionomer Material



Available Packing : 15g Powder, 10ml Liquid, Scoop/Spatula & Mixing Pad

Prime Cem Ceramic Reinforced

Glass Ionomer Material
 Contains Zirconium Oxide



Available Packing : 15g Powder, 10ml Liquid, Scoop/Spatula & Mixing Pad

Restorite Ionomer Flow

2026 Launch

Light Cure Glass Ionomer
 Composite Cement



- High Compressive Strength
- Radiopaque
- Composition: Acrylate Monomer Glass Ionomer-Based Filler



Available Packing : 2g syringe

Etchant

Etching Gel

Blue Color

Flowable



37% Phosphoric Acid
 Enamel Etchant.
 Silica Free

Available Packing • **Regular Pack** : 3ml syringe & 5 application needles • **Big Pack** : 2 x 25ml syringe, 50 application needles; 1 contactor & 2 x 3ml empty syringe.

Restorite Etching Gel

Purple Color

Thixotropic



37% Phosphoric Acid
 Enamel Etchant.
 Contains Silica

Available Packing • **Regular Pack** : 3ml syringe & 5 application needles • **Big Pack** : 2 x 25ml syringe, 50 application needles; 1 contactor & 2 x 3ml empty syringe.

Etching Liquid



37% Orthophosphoric acid

- Enamel Etchant.
- Silica free.
- Thick liquid consistency.

Available Packing : 15ml Bottle

Bonding Agent

Restorite Bond 5G

5th Generation Bonding Agent for
 Dentine /Enamel



- Light-cured one component Total Etch System.
- Provides very good adhesion to dentine and enamel.

Available Packing : 5ml bottle

Restorite Bond 7G

7th Generation Self Etch
 Bonding Agent For Dentine & Enamel



- Light cured one component Self Etch Bonding System
- Provides very good adhesion to dentine and enamel

Available Packing : 5ml bottle

Flowable Composite

PurpleSeal



Flowable Composite for Sealing Orifice and Pulpal Floor

- Light-Cured Flowable Purple Composite
- High Filler Load: 67%
- Easy Identification of Orifice During Retreatment
- Can Also Be Used for Pulpal Floor Sealing
- Radiopaque

Available Packing : 2g Syringe & 5 Applicator Tips

Restorite Bulk Fill (Flowable)

Light Cure Flowable Bulk Fill Composite Filling Material



- Depth of cure 4mm
- Available Shade
Universal



Available Packing : 2g syringe

Restorite Flow Viscous

Light Cure Flowable Viscous Composite Filling Material



Available Shade
A1
A2
A3
B2



Available Packing : 2g syringe

Restorite Ionomer Flow

2026 Launch

Light Cure Glass Ionomer Composite Cement

- High Compressive Strength
- Radiopaque
- Composition: Acrylate Monomer Glass Ionomer-Based Filler



Available Packing : 2g syringe

Restorite Bulk Fill Kit (Flowable)



Contents:

- Restorite Bulk Fill Flowable (2gm) - 4
- Application Needles for Restorite Bulk Fill Flowable - 20



Shades included : Universal - 4

Restorite Flow Viscous Kit



Contents:

- Restorite Flow Viscous (2gm) - 4
- Application Needles for Restorite Flow Viscous - 20



Shades included: A1, A2, A3 & B2

Restorite Pit & Fissure Sealant

Light Cured Universal Shade Fissure Sealant

Available Shade
Universal Shade



Available Packing : 2g syringe

Packable Composite

BiteRise

2026 Launch



Bite Raising Composite

- For Easy Identification
- For Creating Temporarily Bonded, Raised Occlusal Surfaces of Disoccluded Teeth
- Can Also Be Used for Deep bite and Cross bite
- Easy to Apply and Remove



Available Packing : 4g syringe

Restorite Bulk Fill (Packable)

Light Cure Packable Bulk Fill Composite Filling Material

- Depth of cure 4mm

Available Shade
 Universal



Available Packing : 4g syringe

Restorite Micro Hybrid

Light Cure Resin-Based Dental Restorative Material

Available Shade
 A1, A2, A3, A3.5, B1 & B2



Available Packing : 4g syringe

Restorite Nano Hybrid

Light Cure Resin-Based Dental Restorative Material

Available Shade
 A1, A2, A3, B2



Shades included : 4g Syringe

Restorite Core Build-Up

- Depth of Cure 6mm



Available Shade
 Translucent Shade



Available Packing : 4g syringe

Restorite Bulk Fill Kit (Packable)



Contents:

- Restorite Bulk Fill Packable (4gm) - 7
- Restorite Bond 7G (5ml) - 1
- Restorite Etching Gel (3ml) - 1
- Aster Compo (4g) - 1
- Application Needles for Restorite Etching Gel - 5
- Microbrush - 10

Shades included: Universal - 7

Restorite Micro Hybrid Kit



Contents:

- Restorite Micro Hybrid (4gm) - 7
- Restorite Bond 7G (5ml) - 1
- Restorite Etching Gel (3ml) - 1
- Aster Compo (4g) - 1
- Application Needles for Restorite Etching Gel - 5
- Microbrush - 10

Shades included: (A1 - 2) (A2 - 2) (A3 - 2) & (B2 - 1)

Restorite Nano Hybrid Kit



Contents:

- Restorite Nano Hybrid (4gm) - 7
- Restorite Bond 7G (5ml) - 1
- Restorite Etching Gel (3ml) - 1
- Aster Compo (4g) - 1
- Application Needles for Restorite Etching Gel - 5
- Microbrush - 10

Shades included: (A1 - 2) (A2 - 2) (A3 - 2) & (B2-1)

Liquid Resin

Restorite Cavo Surface Sealer



Light Cured; Unfilled Methacrylate Resin-Based Cavo Surface Sealer

- For better margin integrity.
- For filling micro cracks.
- Can be used for GI and Composites.

Available Packing : 5ml bottle

Restorite Modelling Resin



Composite Sculpting Agent

- Low viscosity light curable resin for sculpting of composite.

Available Packing : 5ml bottle

Orthodontic Material

BiteRise
 2026 Launch



Bite Raising Composite

- **Blue Color** for Easy Identification
- For Creating Temporarily Bonded, Raised Occlusal Surfaces of Disoccluded Teeth
- Can Also Be Used for Deep bite and Cross bite
- Easy to Apply and Remove

Available Packing : 4g syringe

Restorite OrthoGrip Composite

2026 Launch

Light Cure Orthodontic Bracket Adhesive



Available Packing : 5g syringe

Restorite OrthoGrip Primer

2026 Launch



Available Packing : 5ml bottle

Restorite OrthoGrip Composite Kit

Light Cure Orthodontic Adhesive System



Available Packing • Kit

- Restorite OrthoGrip Composite (5g) - 1
- Restorite OrthoGrip Primer (5ml) - 1
- Restorite Etching Gel (3ml) - 2
- Application Needles for Restorite Etching Gel - 10
- Microbrush - 10



Gingival Barrier

GingiSafe

Light Cure Gingival Barrier / Liquid Dam



Available Packing : 1.2ml syringe

GingiSafe Kit

Light Cure Gingival Barrier / Liquid Dam



Available Packing : Kit : GingiSafe (1.2ml)- 4, Application Needles - 8

Bleaching System

LilyBright

2026 Launch



Fast Acting In-Office Whitening System 35% Hydrogen Peroxide with pH-Activation and Desensitiser

Available Packing • Kit

- LilyBright Powder (0.3g) - 2
- LilyBright Liquid (3ml) - 2
- GingiSafe (1.2ml) - 1
- Microbrush - 2
- Applicator Tips - 2



Desensitisers

Desensitiser

Contains Potassium Oxalate

- Blocks dentinal tubules.
- For immediate relief from sensitivity.
- Use after vital crown cutting.



Available Packing : 3g syringe & 5 application needles

Restorite Desensitiser



Available Packing : 5ml bottle

Liquid Solution for Hyper Sensitivity

- To treat pain in exposed cervical areas not indicated for restoration
- To alleviate or prevent dentinal sensitivity after preparation of teeth to receive direct or indirect restorations.
- For total etch system Restorite Desensitiser can be used as a re-wetting agent.

Prophylaxis & Polishing System

Aster Compo



Available Packing : 4g Syringe

Alumina Based Polishing Paste for Polishing Dental Composites.

- Non-splattering.
- Thixotropic nature.
- Mint fragrance.
- Fine grit.

Aster Prophy CE Prophylaxis Paste



- Dental Prophylaxis Paste for polishing & removal of plaque & stains.
- Thixotropic nature.
- Non-splattering effect.
- Pumice based.
- Fluoride free.



Aster Prophy (Pack of 4) CE



New Flavours :



Available Packing : 45g tube / Assortment pack of 4 / 200g Jar

Miscellaneous

BiofilmX CE



Dental Chair Unit Waterline Biofilm Reducer

- Ready-to-use solution
- Economical method to maintain dental chair unit tubing hygiene
- 1 bottle offers 4 uses of 125ml each
- For new clinical setup only 125ml once a week is sufficient to obtain optimum results
- For old clinical setup 125ml needed for each day for the first 5 days and there after 125ml once a week is sufficient to obtain optimum results

Available Packing : 500ml Bottle

Debubbler CE



Reduce Surface Tension Non Foaming Solution

- Spray to be Used Before Pouring Impressions or Wax Patterns
- Helps to avoid bubbles while pouring models.
- Fast drying surface tension reducer & cleanser.

Available Packing : 100ml Spray Bottle / 500ml Refill Jar

NT Fog CE



Spray for Anti-Fog

- Effectively used on MM tops to make it fog free.

Available Packing : 100ml Spray Bottle

Caries Indicator



- Dye which shall stain carious dentin to bright red. This would enable dentist to distinguish carious lesion.
- Available colors : Red & Blue.

Available Packing : 15ml bottle

Dent Dry



Dentin Drying & Cleansing Agent

- For having moist dentin surface
- Use before bonding of dentin
- Use before root canal sealant

Available Packing : 30ml bottle

Prime Instrument Rust Remover

2026 Launch

For Bright Instruments



- Compatible with ultrasonic bath
- Works in few minutes
- Can be used as cleansing agent
- 1 : 10 dilute and use

Available Packing : 500ml Bottle

ProstoClean

2026 Launch

Cleaning Bonding Surface of Prosthesis



- Extra Oral Use Only
- Cleans Bonding Surfaces of All Types of Restorations After Try-In
- Can Be Used with Zirconia, Ceramic, Metal, Composite, etc.
- Optimizes Adhesion with Cements

Available Packing : 5ml bottle

Prime Dental X-Ray Film Speed E



Size 2 (31 mm x 41 mm)
Extra Soft

Available Packing : **150 Films**

PRIME Cord Retraction Cord

- » Extended length
20% longer
(120 inch / 305 cm)
- » 100% Cotton
Knitted retraction cord
- » Hydrophillic dye
Without fluorescent
whitening agent

**20%
Longer**

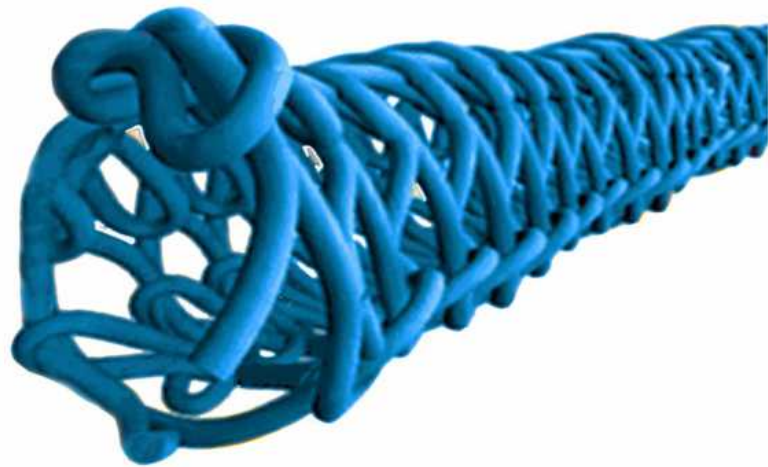

Easy Cut

Very Convenient to cut



Smart Ruler

Allows to measure the length



#000 - Ultra-Fine (Black)



#00 - Extra-Fine (Yellow)



#0 - Fine (Purple)



#1 - Medium (Blue)



European product

Excellent Features

Cost Effective

Hi-REM Post Starter Kit



9 Posts (#0, #1 & #2 - 3 pcs each)
3 Drills (#0, #1 & 2-1 pc each)



The High Resistance Material



The Aesthetic Material



Easy & Fast Removal Fiber Post



Hi-Rem Post, the Overfibers' patented fiber post, it is the only one that has the great advantage to be easily removable when it is necessary

Hi-REM Post Refill Pack



10 Posts (#0 / #1 / #2 / #3)

Hi-REM Post Drills

1 Pack = 1pc (#0 / #1 / #2 / #3)

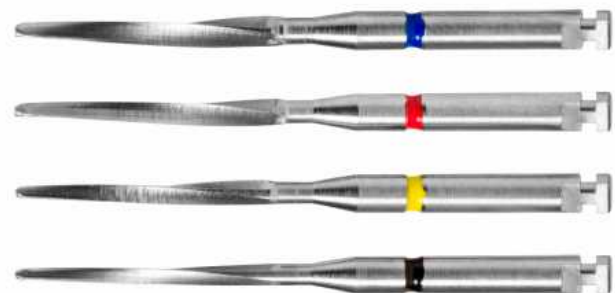

Size	Max Ø	Min Ø	Conicity %
# 0	1.20	0.70	0.04
# 1	1.40	0.80	0.05
# 2	1.60	0.80	0.06
# 3	1.80	0.90	0.08

Features

Advantages

High retentive surface	Increases the post / cement adhesion without weakening it with deep grooves
Zirconia glass fiber 80%	High flexure strength 1600 Mpa
Balanced flexure E-modulus	60 GPa to better stabilize the restoration
Highly Translucent	Provides esthetics & light transmission
Radiopacity	3.0 mm or 300% Al equivalent
Fatigue Strength	5 Millions cycles without breaking
Sterilization in autoclave	135°C at 2.1 bar for 5 min without any variation of their resistance
Easy to remove	Safely with absolute certainty & without tooth damages



Integrated Endodontics

i-Post

Make in India

Integrated Endodontics

First Indian Intra-radicular Anchorage
Passive, Parallel & Pillar-like

- ✓ User friendly – matches with peeso drill
- ✓ 100% indigenous – Indian
- ✓ Prefabricated – ready to use
- ✓ Strong-solid metal
- ✓ Pointed tip and easy identification
- ✓ Inbuilt flare to compensate anatomical coronal flare.
- ✓ Stable-due to design

Available Sizes: 10 Post of same sizes



i-Sleeve

Preventive measure for Apex Locator
For accurate readings
Acts as an insulator to #10 K File
Avoids leakage of the current



i - Grip- Implant / Endo

Rubber Dam Application is the first STANDARD OF CARE in Endodontics



Indications

- Patients having claustrophobia
- Patients having severe gagging
- Badly mutilated teeth - second and third molars
- Unco-operative pedo & adult patients
- Use of Hex Driver during implant procedure

i - Grip-Implant

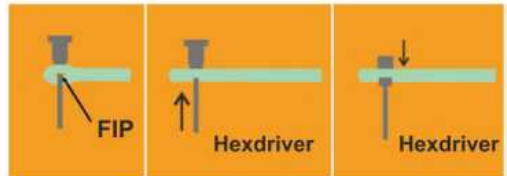

Insert Hex Driver in a Punched hole on FIP

i - Grip-Endo

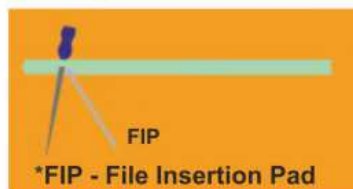

*FIP - File Insertion Pad

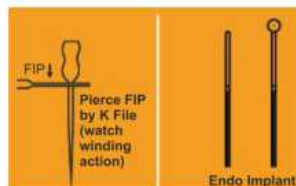

One can punch the hole with the help of rubber dam punch

Mi - EndoUltra Tips

Swadeshi

Integrated Endodontics

Multi purpose Ultrasonic Endo Tips

Applications

- ✓ Locating Canals
- ✓ Removal of pulp stones
- ✓ Agitation of NaOCl and EDTA
- ✓ Warm Gutta Percha Technique
- ✓ Removal of broken instrument

Benefits:

- ✓ Controlled cutting
- ✓ Better vision
- ✓ Less chances of accidents like perforation
- ✓ Economical agitation
- ✓ Economical warm obturation

Available Sizes: (Pack of one)



For more details: www.integratedendo.com





DIAMOND BURS FG

A BRAZILIAN BRAND
 CREATING SMILES
 WORLDWIDE.













QUALITY APPROVED
 BY DENTISTS IN **+ 95 COUNTRIES**



											
TF-11 ISO 173/014	TF-12 ISO 173/015	TF-13 ISO 173/018	TF-14 ISO 172/022	TF-20 ISO 171/014	TF-21 ISO 171/016	TR-11 ISO 199/015	TR-12 ISO 199/016	TR-14 ISO 198/022	TR-19 ISO 200/018	TR-20 ISO 197/014	TR-21 ISO 197/016
TF SERIES						TR SERIES					

										
TR-25 ISO 198/025	TR-26 ISO 198/018	TC-11 ISO 299/016	TC-21 ISO 298/014	TC-26 ISO 164/011	FO-11 ISO 299/012	FO-21 ISO 297/014	FO-22 ISO 298/016	FO-25 ISO 243/028	FO-27 ISO 243/032	FO-32 ISO 243/018
TC SERIES					FO SERIES					

									
SF-11 ISO 111/012	SF-12 ISO 111/014	SF-13 ISO 111/016	SF-21 ISO 110/014	SF-31 ISO 109/013	SF-41 ISO 109/010	SO-20 ISO 288/012	SO-21 ISO 289/014	SR-11 ISO 141/012	SR-12 ISO 141/014
SF SERIES			SO SERIES			SR SERIES			

*Dimensions of the product may vary from the image representation



EX-11 ISO 039/032 **EX-20** ISO 237/018 **EX-21** ISO 237/021 **EX-24** ISO 220/018 **EX-26** ISO 237/032 **BR-31** ISO 001/018 **BR-40** ISO 001/016 **BR-41** ISO 001/014 **BR-45** ISO 001/010 **BR-46** ISO 001/012 **BR-49** ISO 001/007

EX SERIES

BR SERIES



DI-41 ISO 019/010 **DI-42** ISO 019/013 **SI-46** ISO 010/012 **SI-47** ISO 010/014 **SI-48** ISO 010/017 **RS-11** ISO 199/018 **RS-21** ISO 197/018 **WR-13** ISO 068/041 **TC-S21** ISO 298/014 **TF-S21** ISO 171/016 **TR-S13** ISO 198/018 **TR-S21** ISO 197/016 **TR-SS21** ISO 197/016

DI SERIES

SI SERIES

RS SERIES

WR SERIES

S SERIES

SS SERIES



BR-31C ISO 001/018 **FO-32C** ISO 243/018 **FO-54C** ISO 190/018 **SF-12C** ISO 111/014 **TC-11C** ISO 299/016 **TF-13C** ISO 173/018 **TR-13C** ISO 198/018 **TR-62C** ISO 198/021 **WR-13C** ISO 068/041

C SERIES



CR-11EF ISO 856/025 **EX-21EF** ISO 237/021 **TC-11EF** ISO 299/016 **TC-21EF** ISO 298/014 **TF-12EF** ISO 173/015 **TF-21EF** ISO 171/016 **TR-11EF** ISO 199/015 **TR-13EF** ISO 198/018 **TR-21EF** ISO 197/016 **TR-S21EF** ISO 197/016 **TR-25EF** ISO 198/025 **TR-26EF** ISO 199/018

EF SERIES



EX-26SC ISO 237/032 **TC-11SC** ISO 299/016 **TF-12SC** ISO 173/015 **TR-21SC** ISO 197/016 **WR-13SC** ISO 068/041

SC SERIES

*Dimensions of the product may vary from the image representation

Allure

Dental Equipment



High Speed Dental Turbine Handpiece

Push Button

Open-Type Cartridge

Standard Head

Super Torque

1 LED Super Torque

Low Speed Dental Handpiece

Straight

Contra Angle

Air Motor

*The functional warranty will be void if there is any physical damage.

Dentaport ZX

Apex Locator

Reliable apex localization



Tri Auto Mini

Endo Motor Compatible with RZM

Compact, cordless endodontic handpiece

9mm only

Automatic Controls (when connected to Root ZX mini)

- Canal Measurement Meter Display
- Auto Apical Stop or Reverse
- Auto Start and Stop
- Auto Apical Slow-down
- Auto Apical Torque Reduction

weight
100g
including
contra angle &
lithium batteries

Root ZX Mini

Apex Locator Compatible with TAM

Measures root canals accurately & precisely



Combo Offer

Root ZX mini
+
Tri Auto mini
+
Accessories

- Transmission Cable
- File Electrode



Safety functions prevent
over - preparation,
misalignment of files & injuries



MADE IN JAPAN

Beyond Ingenuity - Intelligent Endodontic Motor

Tri Auto ZX2+

Cordless Endo Motor with built-in Apex Locator

- Next Level Reciprocation - Introducing OGP2
- The Efficiency of OTR
- World-leading apex location Built Right in
- Various Modes

**Patency and Glide Path
Have Never Been Easier**

Various Modes

EMR

for Apex Location

CONT CW

Motor rotates continuously clock-wise

CONT CCW

Motor rotates continuously counter clock-wise

OGP

Optimum Glide Path

OGP 2

Optimum Glide Path 2

OTR

Optimum Torque Reverse

weight
140g

including
contra angle &
lithium batteries

Upper Part Enlargement

Patency

Apex Location & Determining
Working Length

Glide Path

Shaping



OGP Mode

OGP (Optimum Glide Path) Function



* Illustration is for 90 setting.
A 90°F & 90°R → B 90°F & 120°R

Repeat the watch-winding (A) and balanced force (B) motions.

OGP2 Mode

OGP2 (Optimum Glide Path 2) Function



A 150°F & 60°R → B 60°F & 150°R
Four times → Four times

OTR Mode

OTR (Optimum Torque Reverse) Function

OTR CW

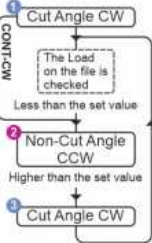

Normal Rotation



Load

OTR Action



* Illustration is for OTR-CW (cut angle 180, non-cut angle 90)

OTR CCW

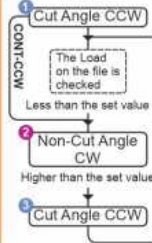

Quick Guide Videos



Before Use & Reprocessing



Basic Usage



Advanced Usage

MADE IN JAPAN



Features

*The chair image is illustrative; actual items included will be as per your quotation.

- Programmable Dental Chair Unit with 3 Variable Programs, 3 Fixed Programs - Z (Zero); G (Gargle); E (ER Working Position)
- LED X-Ray viewer, Pressure gauge
- 2 High-speed Airtor connections & 2 Three-way syringe
- In-built E-Type Micro Motor Kit with Engine
- In-built LED Scaler with 5 Tips
- Pneumatic lock for control box arm
- Large instrument base on control box
- LED (6 LED) Light multi-intensity with sensor
- 2 Arm rest
- Joystick foot control on the base of the unit
- Master foot control with S (Spittoon)/T (Tumbler) switch
- Glass spittoon with definable timer control water filling system
- Assistant's side control 3-way syringe; Low & High venture suction
- Broad base for better stability
- Doctor's stool
- Emergency Stop switch on control box
- Cup mounted on control box to collect the waste during treatment



C-1



C-2



C-4



C-5



C-6



C-7



C-8



Detachable Spittoon



Movable Side Unit



Assistant's side controls



Features

*The chair image is illustrative; actual items included will be as per your quotation.

- Programmable Dental Chair Unit with 2 Customised Programs, Last position/Gargle & Zero are Fixed Programs,
- Timer customizable for Cup Filler (Warm Water option) and Bowl Rinse
- 7" LED X-Ray film viewer ● Pressure gauge
- High-speed airtor connections x 2, three-way syringe x 1
- In-Built Woodpecker LED Scaler With 5 tips
- Touch Panel ● Pneumatic lock for control box arm
- Movable arm rest for easy entry / exit for patients
- LED Reflection type Dental Light with sensor (Luminance up to 30,000 Lux at Standard Mode) (Luminance up to 20,000 Lux at Yellow Mode)
- Multi functional foot control
- Detachable Spittoon with 180 deg swivel
- Master Switch for Power / Water & Air On / Off
- Emergency Stop Switch
- **Assistant's side controls:**
Chair movement control, Light On / Off, Cup Filler, Bowl Rinse, Last position/Gargle, Zero, M1, M2, Three-way syringe x 1, HVE x 1, Saliva ejector x 1, Instrument tray
- In-Built Woodpecker LED Light Cure Unit
- Compact side unit with 90 deg swivel
- Distilled water bottle x 1 (Also for tap water), Disinfection bottle x 1

Optional

- In-Built Micro Motor Kit With Engine

Touch Panel

Doctor's Stool

- **Relax Position**
Adjustable Backrest Height & Recline
- **Consulting Position**
For comfortable posture
- **Operational Position**
Adjust the backrest and the seat-rest at incline angle

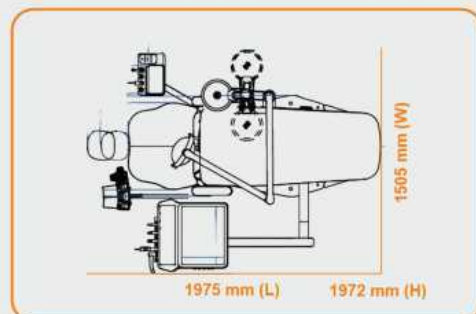

PVC - 1



PVC - 2



PVC - 3



PVC - 4



PVC - 7



PVC - 12



Features

*The chair image is illustrative; actual items included will be as per your quotation.

- Programmable Dental Chair Unit with 9 Customised Programs (3 Users x 3 Programs), Fixed Programs: Last position/Gargle, Zero, Spittoon Clean & Trendelenburg Position (Shock Position)
- Timer customizable for Cup Filler (Warm Water option) and Bowl Rinse
- 7" LED X-Ray film viewer ● Digital Pressure gauge
- High-speed airtor connections x 3, Three-way syringe x 1
- In-Built Woodpecker LED Scaler With 5 tips
- LCD Display Touch Screen ● Touch lock for control box arm
- Movable arm rest for easy entry / exit for patients
- LED Reflection type Dental Light with sensor (Luminance up to 30,000 Lux at Standard Mode) (Luminance up to 20,000 Lux at Yellow Mode)
- Multi functional foot control
- Detachable Spittoon with 180 deg swivel
- Master Switch for Power / Water & Air On / Off
- Emergency Stop Switch
- Assistant's side controls: Chair movement control, Light On / Off, Cup Filler, Bowl Rinse, Last position/Gargle, Zero, M1, M2, Three-way syringe x 1, HVE x 1, Saliva ejector x 1, Instrument tray
- In-Built Woodpecker LED Light Cure Unit
- Compact side unit with 90 deg swivel
- Distilled water bottle x 1 (Also for tap water), Disinfection bottle x 1

LCD Display Touch Screen

Doctor's Stool

- Relax Position Adjustable Backrest Height & Recline
- Consulting Position For comfortable posture
- Operational Position Adjust the backrest and the seat-rest at incline angle

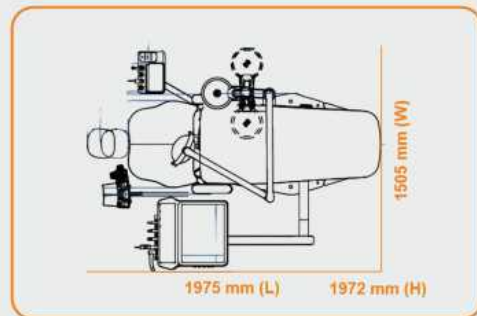

PVC - 1



PVC - 2



PVC - 3



PVC - 4



PVC - 7



PVC - 12



Light Cure Unit (Cordless)

1 Sec Light Cure Unit



3 working modes :

M1 : Light intensity :
2300-2700mW/cm²
Time for choices :
1s,3s,5s

M2 : Light intensity :
1700-1900mW/cm²
Time for choices :
5s, 10s, 15s, 20s

M3 : Light intensity :
1300mW/cm²
Time for choices :
5s, 10s, 15s, 20s,
25s, 30s, 35s, 40s,
45s, 50s, 55s, 60s



Allure

A wide range of Dental Equipment

Multi-Function Light Cure Unit



Working modes :

2 Modes available in LED

1. High Curing Mode

- 2300-2500 mw/cm²
- 1 Second
 - 3 Second

2. Normal Mode

- 1000-1200 mw/cm²
- 5 Second
 - 10 Second
 - 15 Second
 - 20 Second



Composite Heater



Range 40^{°C} TO 70^{°C}

STANDBY MODE



HEATING MODE



MODE SETTING



• Can also heat Sodium Hypochlorite in syringe

External Oral Suction ES 500

Allure

A wide range of Dental Equipment



With
Wireless Remote

High-end
Touch Panel



ES 500 has a 4 layer filtration & 1 UVC lamp

- 1 layer of washable cotton filter
- 1 layer of water vapor absorbing filter
- 1 layer of H13 HEPA
- 1 layer of active carbon filter

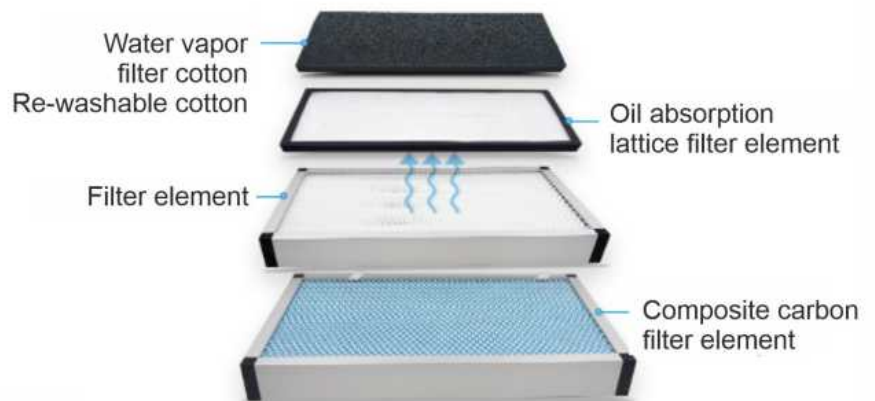

Voltage:
110V 60hz/220V 60hz
Noise: 30-40db

N.W: 18.6kg

Size: 50x33x53cm

Air Flow Rate: 310m³/h
Negative Pressure: 3.2kpa
Filtration: 0.3 u m 99.96%

External Oral Suction ES 1000

**Greatly reduces the risk of cross infection
between doctors & patients
& protects respiratory health**



Voltage/Frequency:
110V-240V, 50HV/60HV

Rated power:
1000W

Control mode:
Touch screen/
two gears adjustable

Suction flow:
4000L/min

Filtration efficiency:
99.9%

Noise:
≤ 60db

Product Size:
32X33X75.5cm
Arm Length 1.3m

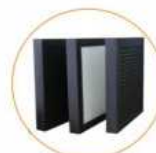

Efficient Filtration



Segmented Rotary Arm



High-end Touch Panel

- Power suction motor (Keeps strong suction)
- Double activated carbon + HEPA high precision filter (4 quadruple filtering)
- UV-C Irradiation + Plasma sterilization
- Easily solves harmful substances such as air-liquid droplets, aerosols, cutting dust & odors in clinic



PRIME Saliva Ejectors

- Vented - Bonded - Flexible Tips
- Soft cushioned vinly tips
- Easily Shaped
- Wire re-inforced
- Non Toxic

100 pcs

Transparent / Clear tip
Disposable / Single use

India's First Integrated Nitrile Gloves

**Nitrile Examination
Gloves** Powder-Free
Disposable | Non- Sterile



Sizes :

XS / S / M / L (100 Pcs / Box)

PRIME Gloves



Natural Color

Finger Textured
Powdered

Available in sizes
Large (100 Pcs / Box)

Latex



PRIME Mask



Disposable & Non Sterile Face Mask

- Non-woven
- Non Irritating
- Water repellent
- Ultrasonic sealing
- Resistance to airborne particles
- Colors : Blue • Type : 3 ply
- Quantity : Elastic 100 Pcs / Box

Face Shield

Effectively protecting faces
Efficiently isolating viruses

- Safe
- Clear vision
- Light & Easy
- Skin-Friendly
- Soft material
- Ergonomics design
- Comfortable to wear
- Double-sided
Antifogging

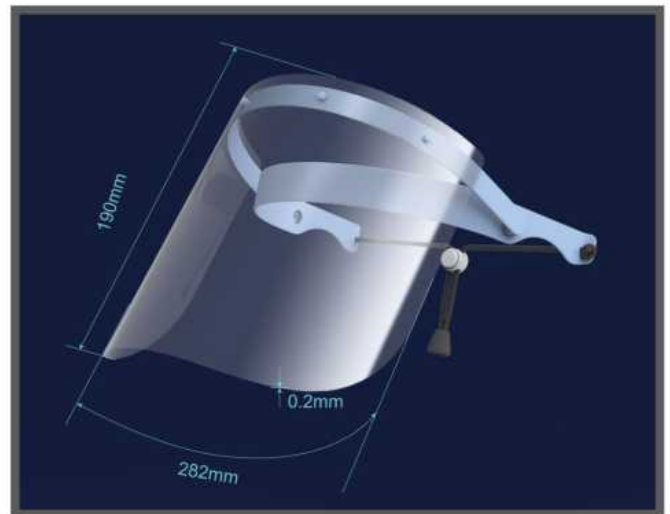

Anti-Dust



Anti-Droplets



Detachable
Shield



Anti-Splash



Anti-Fog

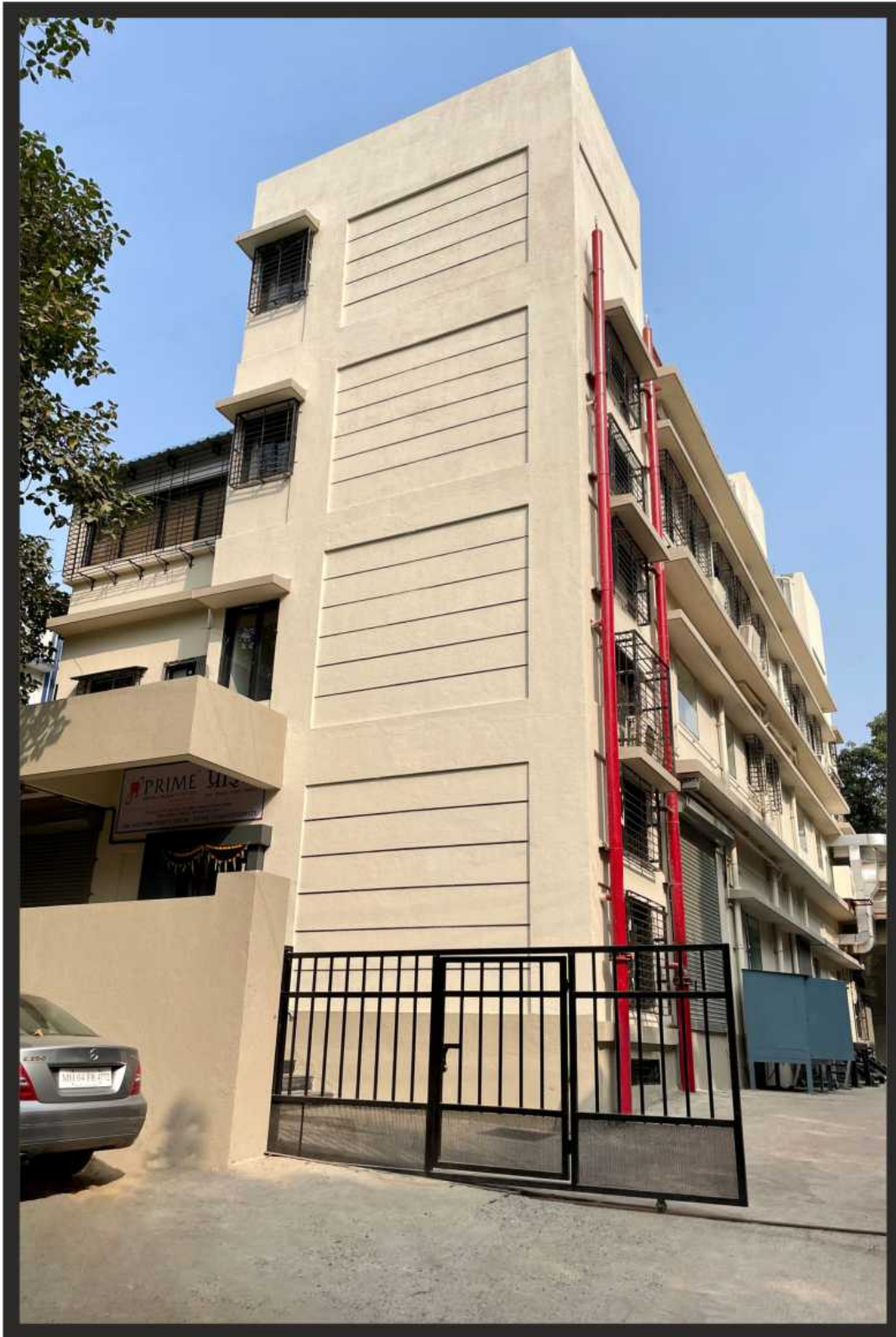

Imported / Marketed



MORITA
Thinking ahead. Focused on life.

Allure

SILVERFOX

overfibers



MICRODONT



**Integrated
Endodontics**

Prime Dental Products Pvt Ltd

Plot No. A-148, Road No. 24, MIDC, Wagle Industrial Estate,
Thane (West)-400604, Maharashtra, India.

+91 9272235922

info@prime-dental.in

www.Prime-Dental.in

