



PRIME[®]

DENTAL PRODUCTS PVT LTD

Established in 1987

Manufacturer & Importer of Dental Materials & Equipment

Product Catalog 2026-27

Class I



MFG/MD/2023/000109
MFG/MD/2023/000100



Prime-Dental.in



+91 9503289380



info@prime-dental.in

About us



Company Overview:

Prime Dental Products Pvt Ltd is a Manufacturer & Importer of Medical Devices. It was established in 1987 by Mr Bharat Thakkar & Dr Paresh Thakkar as a dental trading concern. Today, we are one of the leading dental manufacturers in India with a manufacturing facility spread over 13,000 sq. ft. of state-of-the-art, ISO 13485:2016 Certified space, located in Western India's most premium industrial zone, MIDC Wagle Estate. We serve the dental community in length & breadth of India with the widest dealer network. We also offer our manufactured dental line internationally through our overseas trade partners. Prime Dental wants to serve the dental fraternity with even more commitment with the next generation Mr Tanay Thakkar & Mr Jay Thakkar joining in.

Dental Materials - 'Make in India' initiative:

We are committed to serve the dental community offering globally acceptable quality products at competitive prices and timely delivery.

Our product range include;

- **Endodontic materials:** MTA Bioceramic Sealer, RC Help (EDTA Gel), RC Cal (Calcium hydroxide in ready to use paste form for temporary RC filling), RC Seal (Epoxy Bonded RC Sealant).
- **Prosthodontic materials:** Prime Chrome (Chromatic alginate impression material), Retra Gel (Retraction Gel) & the foremost manufacturer of Addition silicone impression material (Ad Sil Acura), Bite Registration Putty.
- **Conservative materials:** Restorite Etching Gel (37% orthophosphoric acid gel), TMP-RS (Ready to use temporary filling putty material), Dent Wash (Liquid EDTA).
- **Finishing materials:** Aster prophyl (pumice based prophylaxis paste) and Aster Compo (Alumina based composite polishing paste).
- **Composites:** Restorite range of Composites offers first in class physical properties viz. Bulk Fill, Flow Viscous, Pit & Fissure Sealant, Micro Hybrid Composite, Nano Hybrid, Core Build-up, Restorite Bond 5G (Total etch), Restorite Bond 7G (Self etch).

Import & Distribution:

Since 1991, Prime Dental is representing many renowned international brands in India.

Dental Equipment:

Since 2007, We are dealing in the finest quality of fully programmable electrical Dental chairs & heavy/light Suctions. We have various models of diverse range to cater all your requirements. We specialize in new clinic setup & up-gradation with robust after-sale service.

OBL Products:

Prime Products: Prime X-Ray Film, Prime Cord (Knitted Retraction cord), Prime Disposables (Gloves, Face Mask, Saliva Ejectors).

Allure : Airotors.

Achievements:

Best Dental Manufacturer - Make in India
at 1st National Oral Healthcare Sushruta Awards
hosted by Indian Dental Association (IDA) Foundation
at the hands of Honourable Former President of India,

Dr. A. P. J. Abdul Kalam



Top Products ✦

**Explore Our
 Bioceramic
 Innovation**

BioTemp
 Ready-to-Use
 Bioceramic Intra Canal Filling Material
 Non-Setting Paste
 3g Syringe & 5 Capillary Tips

Prime MTA
Bioceramic
 Root Canal Sealer
 3g Syringe & 15 Capillary Tips

Prime MTA
BioPutty
 Ready-to-Use
 Bioceramic Putty for Root Repair
 Highly Radiopaque
 2g Syringe

**Flowable Composite for Sealing
 Orifice & Pulpal Floor**



PurpleSeal
 Flowable Composite for Sealing Orifice & Pulpal Floor
 Purple Shade
 2g Syringe

**Calcium Hydroxide Iodoform Paste
 Temporary Root Canal Filling Material**

RC Pex
 Calcium Hydroxide Iodoform Paste
 Temporary Root Canal Filling Material
 Highly Radiopaque
 3g Syringe & 5 Capillary Tips

Glass Ionomer Cement

Prime Cem Luting
 Glass Ionomer Cement
 1 TYPE

Prime Cem Restorative
 Glass Ionomer Material
 2 TYPE

Prime Cem
 Ceramic Re-inforced
 For Posterior Filling & Core Build-up
 Glass Ionomer Material
 Contains Zirconium Oxide
 Radiopaque
 Universal Shade

Contains Zirconium Oxide

BiofilmX CE



Dental Chair Unit Waterline Biofilm Reducer

- Ready-to-use solution
- Economical method to maintain dental chair unit tubing hygiene
- 1 bottle offers 2 uses of 250ml each
- For new clinical setup only 250ml once a week is sufficient to obtain optimum results
- For old clinical setup 250ml needed for each day for the first 5 days and there after 250ml once a week is sufficient to obtain optimum results

Available Packing : 500ml Bottle

GingiSafe Kit



Light Cure Gingival Barrier / Liquid Dam



Available Packing • **Regular Pack** : 1.2ml syringe
 • **Kit** : GingiSafe (1.2ml)- 4,
 Application Needles - 8

Restorite

Restorite OrthoGrip Kit

Light Cure Orthodontic Adhesive System



Available Packing • **Kit**
 • Restorite OrthoGrip Composite (5g) - 1
 • Restorite OrthoGrip Primer (5ml) - 1
 • Restorite Etching Gel (3ml) - 2
 • Application Needles for Restorite Etching Gel - 10
 • Microbrush - 10

Restorite Bond 5G

5th Generation Bonding Agent for Dentine /Enamel



- Light-cured one component Total Etch System.
- Provides very good adhesion to dentine and enamel.

Available Packing : 5ml bottle

Restorite Bond 7G

7th Generation Self Etch Bonding Agent For Dentine & Enamel



- Light cured one component Self Etch Bonding System
- Provides very good adhesion to dentine and enamel

Available Packing : 5ml bottle

Restorite Bulk Fill (Flowable)

Light Cure Flowable Bulk Fill Composite Filling Material



- Depth of cure 4mm
- Available Shade
Universal

Available Packing : 2g syringe

Restorite Bulk Fill Kit (Flowable)

Contents:

- Restorite Bulk Fill Flowable (2gm)- 4
- Application Needles for Restorite Bulk Fill Flowable - 20



Shades included : Universal - 4

Restorite Bulk Fill (Packable)

Light Cure Packable Bulk Fill Composite Filling Material



- Depth of cure 4mm
- Available Shade
Universal

Available Packing : 4g syringe

Restorite Bulk Fill Kit (Packable)



Contents:

- Restorite Bulk Fill Packable (4gm) - 7
- Restorite Bond 7G (5ml) - 1
- Restorite Etching Gel (3ml) - 1
- Aster Compo (4g) - 1
- Application Needles for Restorite Etching Gel - 5
- Microbrush - 10

Shades included: Universal - 7

Restorite Cal

Light cured Calcium Hydroxide Cavity Base/Liner



- Easy to use, light curable, one component system
- Used for direct and indirect pulp capping
- Used as cavity liner under filling material
- Low solubility

Available Packing : 2g syringe

Restorite Cavo Surface Sealer

Light Cured; Unfilled Methacrylate Resin-Based Cavo Surface Sealer



- For better margin integrity.
- For filling micro cracks.
- Can be used for GI and Composites.

Available Packing : 5ml bottle

Restorite Core Build-Up



- Depth of Cure 6mm
- Available Shade
Translucent Shade

Available Packing : 4g syringe

Restorite Desensitiser

Liquid Solution for Hyper Sensitivity



- To treat pain in exposed cervical areas not indicated for restoration
- To alleviate or prevent dentinal sensitivity after preparation of teeth to receive direct or indirect restorations.
- For total etch system Restorite Desensitiser can be used as a re-wetting agent.

Available Packing : 5ml bottle

✦ Restorite Etching Gel 37% Phosphoric Acid, Contains Silica

Thixotropic



- Opaque bright purple color.
- Enamel etchant.
- Contains silica.
- Thixotropic gel.
- 37% Orthophosphoric acid.

Also available : Blue colour, Flowable consistency, Silica free

Available Packing • **Regular Pack** : 3ml syringe & 5 application needles.
 • **Big Pack** : 2 x 25ml syringe, 50 application needles;
 1 contactor & 2 x 3ml empty syringe.

Restorite Flow Viscous Light Cure Flowable Viscous Composite Filling Material



Available Shade

- A1
- A2
- A3
- B2

Available Packing : 2g syringe

✦ Restorite Flow Viscous Kit



Contents:

- Restorite Flow Viscous (2gm) - 4
- Application Needles for Restorite Flow Viscous - 20

Shades included: A1, A2, A3 & B2

Restorite Micro Hybrid Light Cure Resin-Based Dental Restorative Material



Available Shade
 A1, A2, A3, A3.5, B1 & B2

Available Packing : 4g syringe

✦ Restorite Micro Hybrid Kit



Contents:

- Restorite Micro Hybrid (4gm) - 7
- Restorite Bond 7G (5ml) - 1
- Restorite Etching Gel (3ml) - 1
- Aster Compo (4g) - 1
- Application Needles for Restorite Etching Gel - 5
- Microbrush - 10

Shades included: (A1 - 2) (A2 - 2) (A3 - 2) & (B2 - 1)

Restorite Modelling Resin



Composite Sculpting Agent

- Low viscosity light curable resin for sculpting of composite.

Available Packing : 5ml bottle

Restorite Nano Hybrid Light Cure Resin-Based Dental Restorative Material



Available Shade
 A1, A2, A3, B2

Shades included : 4g Syringe

✦ Restorite Nano Hybrid Kit



Contents:

- Restorite Nano Hybrid (4gm) - 7
- Restorite Bond 7G (5ml) - 1
- Restorite Etching Gel (3ml) - 1
- Aster Compo (4g) - 1
- Application Needles for Restorite Etching Gel - 5
- Microbrush - 10

Shades included: (A1 - 2) (A2 - 2) (A3 - 2) & (B2-1)

Restorite Pit & Fissure Sealant

Light Cured Universal Shade Fissure Sealant



Available Shade
 Universal Shade

Available Packing : 2g syringe

Endodontic

✦ BioTemp

Easy & Ready-to-Use Bioceramic Intra Canal Temporary Filling Material



- Radiopaque
- Intracanal dressing material
- Non-setting, ready-to-use paste
- Contains silicates for gradual release of calcium ions
- Can be left in the root canal for up to 3 weeks
- Easy to remove
- Recommended for use in cases of perforation & resorption prior to Prime's MTA Putty, TA Packable & MTA Bioceramic Sealer

Available Packing : 3g Syringe & 5 Capillary Tips

Citra Wash

20% Citric Acid Solution



- Cleansing/conditioning of prepared canals, and
- Dissolving/cleaning residues of calcium hydroxide
- Removing smear layer

Available Packing : 30ml Bottle.

Prime MTA Bioceramic Root Canal Sealer



- Ready-to-Use Paste.
- Premixed, Easy-to-Use.
- Radiopaque
- Bioactive & Biocompatible
- Hydrophilic

Available Packing : 3g Paste & 15 Capillary Tips

Prime MTA BioPutty

Ready-to-Use Bioceramic Putty for Root Repair

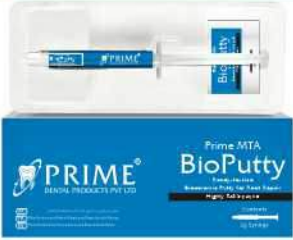

- Putty Consistency
- Non-Staining
- Highly Radiopaque

Available Packing : 2g Syringe

Prime MTA Packable



MTA Packable can be used for Apexification, Repairing root perforations, Internal root resorption and Pulp capping.

Available Packing : 1g Powder & 5ml Liquid

Primecresol



Formocresol

Available Packing : 15ml Bottle

PurpleSeal

Flowable Composite for Sealing Orifice and Pulpal Floor



- Light-Cured Flowable Purple Composite
- High Filler Load: 67%
- Easy Identification of Orifice During Retreatment
- Can Also Be Used for Pulpal Floor Sealing
- Radiopaque

Available Packing : 2g Syringe & 5 Applicator Tips

RC Cal

Without Iodoform



Ready to Use Paste. Intracanal Temporary Filling

- Contains barium sulphate. Radio opaque.
- Highly alkaline Ca(OH)₂ paste.
- Can be easily removed by reamers.
- Non drying paste.

Available Packing • 2g syringe & 5 application needles

RC Cal-I

With Iodoform



Ready to Use Paste. Intracanal Temporary Filling

- Contains barium sulphate. Radio opaque.
- Highly alkaline Ca(OH)₂ paste.
- Can be easily removed by reamers.
- Non drying paste.

Available Packing • 2g syringe & 5 application needles

RC Pex



- Highly radiopaque calcium hydroxide paste with iodoform.
- Capillary tips for easy dispensing.

Available Packing • 3g syringe & 5 Capillary Tips

RC Fill

Without Iodoform



Root Canal Sealant & Filling

- Contains Calacium Hydroxide, Zinc oxide & Eugenol. (Without Iodoform)
- Radio opaque.
- Bioresorbable set mass.

Available Packing : 15g Powder ,10ml Liquid & 5g accelerator

RC Fill-I

With Iodoform



Root Canal Sealant & Filling

- Contains Calacium Hydroxide, Zinc oxide & Eugenol. (With Iodoform)
- Radio opaque.
- Bioresorbable set mass.

Available Packing : 15g Powder ,10ml Liquid & 5g accelerator

RC Help

Lubricating Paste for RC Biomech.



- EDTA paste.
- Contains carbamide peroxide.
- Increases RCT instrument's life.
- Gentle O₂ release while irrigating with NaOCl.
- Cleanses canal

Available Packing • **Regular Pack** : 3g syringe & 5 application needles
 • **Big Pack** : 20g big syringe, 25 application needles, 1 contactor & 3g empty syringe

RC Seal

Epoxy Bonded Root Canal Sealant



- Root canal sealant.
- Epoxy bonded.
- Virtually formaldehyde free.
- Shrink free set.
- Eugenol free.
- Shall not retard composite setting.
- Non Bio Resorbable.

Available Packing : 10g Powder & 10ml Liquid
 ● 10ml refill liquid also available separately

RC Seal Plus

Epoxy Bonded Root Canal Sealant



- Hexamine free Epoxy bonded root canal sealant.
- Easy to mix paste-paste system in a two-barrel syringe.
- High radio opacity.
- Long term sealing properties.
- Good dimensional stability.

Available Packing : 1 x 15.5g Dual syringe

RC Soft

Softens Resin Based Cements



- Softening agent for epoxy resin based root canal sealants.

Available Packing : 15ml bottle

RC Solve

GP & ZnOE Solvent



- Softens GP points.
- Softens zinc oxide cement.
- Controlled penetration to avoid disturbing apical seal.
- Shall not retard composite setting.

Available Packing : 15ml bottle

RC Twents

30 Now in gauge

Irrigation Needle



- Irrigation needle with two side vents.
- Side vent avoids irrigation fluid to be pushed apically.

Available Packing : 10pcs in a pack

Sodium Hypochlorite

For Root Canal Irrigation



- Available in 3% & 5.25% strength
- Mint aroma
- With pH buffer
- Can digest pulpal debris

Available Packing : 500ml Bottle in 3% & 5.25%

Prosthodontic

Prime Cem Luting

Glass Ionomer Cement



Available Packing : 15g Powder, 10ml Liquid, Scoop/Spatula & Mixing Pad

Ad-Sil Acura Bite Registration Putty



- No Heating required
- Addition Silicone based Bite Registration Putty.
- Shore A - 87
- Easy-to-Use
- Can be used for indexing
- No wastage compared to Bite Registration in Cartridge form

Available Packing : 100ml Base & 100ml Catalyst

Ad-Sil Acura Putty - Hard Set



- Shore A-80.
- Addition silicone impression material.
- Accurate detailed reproduction.
- Highly stable impression.
- Compatible to all dye materials.
- Suitable for all impression technique.
- Ideal choice of impression for multiple pouring.

Available Packing : 400g Base & 400g Catalyst

Ad-Sil Acura Putty - Soft Set



- Shore A-60.
- Addition silicone impression material.
- Accurate detailed reproduction.
- Highly stable impression.
- Compatible to all dye materials.
- Suitable for all impression technique.
- Ideal choice of impression for multiple pouring.



Available Packing : 400g Base & 400g Catalyst

Ad-Sil Acura Light Cartridge



Polyvinyl Siloxane Impression Material

- Shore A-65.
- Light body available in dual chamber cartridge.
- Hydrophilic nature.
- Can be used with any other addition silicone putty.

Available Packing : Cartridge 2 x 50ml (Base & Catalyst)

Ad-Sil Acura Light Tubes



Polyvinyl siloxane impression material

- Shore A-65.
- Addition silicone impression material.
- Accurate detailed reproduction.
- Highly stable impression.
- Compatible to all dye materials.
- Suitable for all impression technique.
- Ideal choice of impression for multiple pouring.

Available Packing : Tubes 25ml Base & 25ml Catalyst

Prime Chrome



Chromatic Alginate Impression Material

- Lemon flavour yellow powder.
- Thixotropic.
- Rubber effect.
- Dust free.
- Easy mix formula.
- Stable for 50 hours under humidity.

- Pink color: Mixing
- Light Pink: Working time
- Yellow: Loading time



Available Packing : 450g Pouch

Algingum



Non-Chromatic Alginate Impression Material

- Mint flavour pista green powder.
- Thixotropic.
- Rubber effect.
- Dust free.
- Easy mix formula.
- Stable for 50 hours under humidity.



Available Packing : 500g pouch

Clean Tray



Alginate and Plaster Residue Cleaner

- 250g powder for 2.5 litre solution.
- Biodegradable powder.
- Can clean up to 125 trays.

Available Packing : 250g Powder

Dent Retract



Aqueous Ferric Chloride

- Helps in retraction of gingival.
- Does not retard the rubber base.

Available Packing : 30ml Bottle

Desensitiser



Contains Potassium Oxalate

- Blocks dentinal tubules.
- For immediate relief from sensitivity.
- Use after vital crown cutting.

Available Packing • **Regular Pack** : 3g syringe & 5 application needles
 • **Twin Pack** : 2 x 3g syringe & 10 application needles

Green Stick



Tracing Sticks

- Low fusing compound.
- Soft green tracing sticks.
- For border moulding work.

Available Packing : 10 Sticks in a pack (90g)

Image



Impression Paste for Edentulous Cases

- Zinc oxide base.
- Eugenol free.
- No irritation to lip & mucosa.

Available Packing : 125g Base & 85g Catalyst

Impression Composition **CE**



For Accurate Edentulous Impressions

- High fusing compound.
- Functional impression compound.
- Accurate impression.
- Suitable for primary impression of complete denture prosthesis.

Available Packing : 5 cakes in a pack (200g)

Modelling Wax



- High quality wax.
- Available in gingiva colour.
- Soft for easy moulding.
- Available colour: Pink

Available Packing : 12 Sheets

Retra Gel



25% Aluminum Chloride Gel

- Retra Gel is a 25% Aluminum Chloride aqueous viscous gel.
- No residue or stain making it ideal for use in the esthetic zone.
- The solutions facilitate the insertion of the cord into the sulcus

Available Packing : 3ml Syringe & 5 application needles

Retra Liquid



25% Aluminium Chloride Aqueous Astringent Solution

- For chemical retraction of gingival margin
- Clear transparent solution
- Non-staining
- Use along with Prime Retraction Cord
- Wash after use before final impression

Available Packing : 30ml Bottle

Template



Temporary Luting for C & B

- Two paste system.
- Eugenol free.
- Shall not retard any bonding agent.
- C & B can be removed easily.

Available Packing : 50g Base & 15g Catalyst

Conservative

Aster Compo **CE**

Alumina Based Polishing Paste for Polishing Dental Composites.



- Non-splattering.
- Thixotropic nature.
- Mint fragrance.
- Fine grit.

Available Packing : 4g Syringe

Prime Cem Restorative Glass Ionomer Material



Available Packing : 15g Powder, 10ml Liquid, Scoop/Spatula & Mixing Pad

Prime Cem Ceramic Reinforced

Glass Ionomer Material
Contains Zirconium Oxide



Available Packing : 15g Powder, 10ml Liquid, Scoop/Spatula & Mixing Pad

Aster Prophy **CE**

Prophylaxis Paste



- Dental Prophylaxis Paste for polishing & removal of plaque & stains.
- Thixotropic nature.
- Non-splattering effect.
- Pumice based.
- Fluoride free.

Aster Prophy (Pack of 4) **CE**



New Flavours :



Available Packing : 45g tube / Assortment pack of 4 / 200g Jar

Caries Indicator



- Dye which shall stain carious dentin to bright red. This would enable dentist to distinguish carious lesion.
- Available colors : Red & Blue.

Available Packing : 15ml bottle

Debubblizer



Reduce Surface Tension Non Foaming Solution

- Spray to be Used Before Pouring Impressions or Wax Patterns
- Helps to avoid bubbles while pouring models.
- Fast drying surface tension reducer & cleanser.

Available Packing : 100ml Spray Bottle / 500ml Refill Jar

Dent Dry

Dentin Drying & Cleansing Agent



- For having moist dentin surface
- Use before bonding of dentin
- Use before root canal sealant

Available Packing : 30ml Bottle

Dent Wash

Aqueous EDTA



- 17% EDTA
- For smear layer removal.
- Use before bonding of dentin.
- Use before root canal sealant.

Available Packing : 30ml Bottle

Dentfilloy

Silver Filling Alloy



68% Silver

- Dentfilloy is a superior quality fine grained conventional alloy.

Available Packing : 30g Bottle (Bulk pack on request)

Dentfilloy NG

Silver Filling Alloy



48% Silver

- Dentfilloy is a superior quality fine grained conventional alloy.

Available Packing : 30g Bottle (Bulk pack on request)

Etching Gel

37% Phosphoric Acid, Silica Free



- Blue color.
- Enamel etchant.
- Silica free.
- In soft gel consistency.
- 37% Orthophosphoric acid.

Also available : Purple colour, Thixotropic consistency, With Silica

Available Packing • **Regular Pack:** 3ml syringe & 5 application needles
 • **Big Pack:** 2 x 25ml syringe, 50 application needles, 1 contactor & 2 x 3ml empty syringe.

Etching Liquid

37% Orthophosphoric acid



- Enamel etchant.
- Silica free.
- Thick liquid consistency.
- 37% Orthophosphoric acid.

Available Packing : 15ml Bottle

Mercury

Extra Purified Dental Filling Material
Dental Grade



- Chemically purified

Available Packing : 30g Bottle / 225g Bottle

NT Fog

Spray for Anti-Fog



- Effectively used on MM tops to make it fog free.

Available Packing : 100ml Spray Bottle.

TMP-RS

Temporary Filling Material



- Eugenol Free
- Temporary filling for cavities.
- Sets with moisture.
- Easy to place and remove.
- Two wads to offer maximum protection from moisture.

Available Packing : 40g Bottle

Temporary Filling Calcium Hydroxide Powder



Powder For Dental Cement For Cavity Base

- It can be used for pulp capping. Need to mix with water for injection to make paste of desired consistency while using

Available Packing : 10g Bottle

Temporary Filling Eugenol Liquid



- Used with zinc oxide powder for temporary filling.

Available Packing : 15ml Bottle / 110ml Bottle

Temporary Filling Zinc Oxide Powder



- Used with eugenol liquid for temporary filling material.

Available Packing : 100g Bottle



Zinc Oxide Eugenol Cement Quick Set Polymer Reinforced Intermediate Restorative Material



Available Packing : 15g Powder / 10ml Liquid



Prime Dental X-Ray Film Speed E



Size 2 (31mm x 41mm)
Extra Soft

Available Packing : **150 Films**

PRIME Cord Retraction Cord

- » Extended length
20% longer
(120 inch / 305 cm)
- » 100% Cotton
Knitted retraction cord
- » Hydrophillic dye
Without fluorescent
whitening agent

**20%
LONGER**

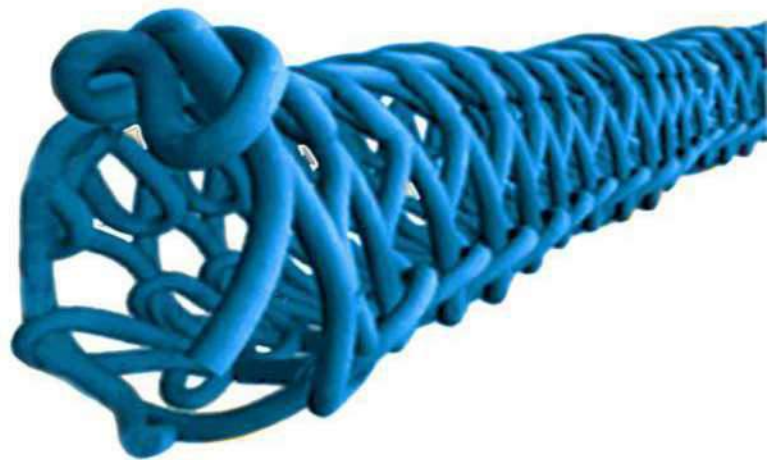

Easy Cut
Very Convenient to cut



Smart Ruler
Allows to measure the length



#000 - Ultra-Fine (Black)



#00 - Extra-Fine (Yellow)



#0 - Fine (Purple)



#1 - Medium (Blue)



European product

Excellent Features

Cost Effective

Hi-REM Post Starter Kit



9 Posts (#0, #1 & #2 - 3 pcs each)
3 Drills (#0, #1 & 2-1 pc each)



The High Resistance Material



The Aesthetic Material



Easy & Fast Removal Fiber Post



Hi-Rem Post, the Overfibers' patented fiber post, it is the only one that has the great advantage to be easily removable when it is necessary

Hi-REM Post Refill Pack



10 Posts (#0 / #1 / #2 / #3)

Hi-REM Post Drills

1 Pack = 1pc (#0 / #1 / #2 / #3)



Size	Max Ø	Min Ø	Conicity %
# 0	1.20	0.70	0.04
# 1	1.40	0.80	0.05
# 2	1.60	0.80	0.06
# 3	1.80	0.90	0.08

Features	Advantages
High retentive surface	Increases the post / cement adhesion without weakening it with deep grooves
Zirconia glass fiber 80%	High flexure strength 1600 Mpa
Balanced flexure E-modulus	60 GPa to better stabilize the restoration
Highly Translucent	Provides esthetics & light transmission
Radiopacity	3.0 mm or 300% Al equivalent
Fatigue Strength	5 Millions cycles without breaking
Sterilization in autoclave	135°C at 2.1 bar for 5 min without any variation of their resistance
Easy to remove	Safely with absolute certainty & without tooth damages



**First Indian Intra-radicular Anchorage
Passive, Parallel & Pillar-like**

- ✓ User friendly – matches with peeso drill
- ✓ 100% indigenous – Indian
- ✓ Prefabricated – ready to use
- ✓ Strong-solid metal
- ✓ Pointed tip and easy identification
- ✓ Inbuilt flare to compensate anatomical coronal flare.
- ✓ Stable due to design

Available Sizes: 10 Post of same sizes

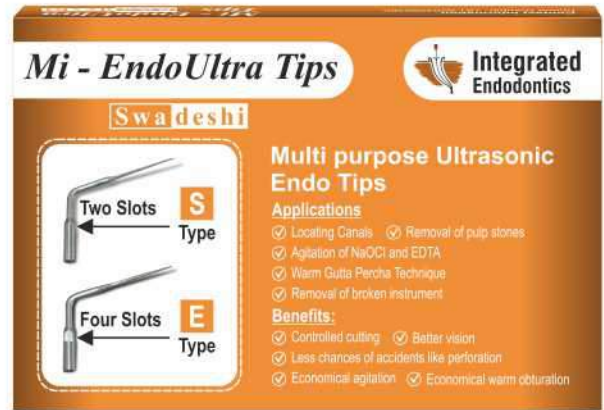

Available Sizes: (Pack of one)



i - Grip- Implant / Endo

Rubber Dam Application is the first **STANDARD OF CARE** in Endodontics



Indications

- Patients having claustrophobia
- Patients having severe gagging
- Badly mutilated teeth - second and third molars
- Unco-operative pedo & adult patients
- Use of Hex Driver during implant procedure

i - Grip-Implant

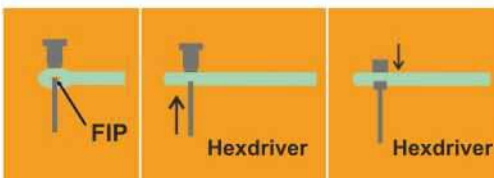

Insert Hex Driver in a Punched hole on FIP

i - Grip-Endo

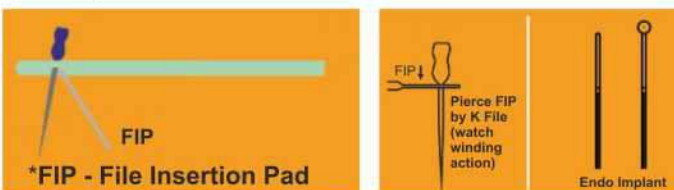

One can punch the hole with the help of rubber dam punch

i-Sleeve

Preventive measure for Apex Locator
For accurate readings
Acts as an insulator to #10 K File
Avoids leakage of the current

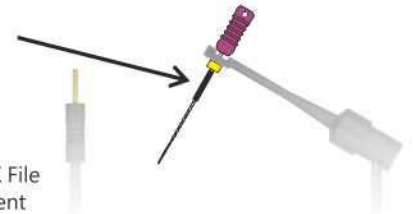

i - Clean Endo Agitator

- Eliminates biofilm and smear layer
- Facilitates upward debris removal
- Favours penetration of irrigants into the non-instrumented zones
- Improves the sealing of the obturation
- Reduces the microbial load
- Improved activation



Allure

Dental Equipment



High Speed Dental Turbine Handpiece

Push Button

Open-Type Cartridge

Standard Head

Super Torque

1 LED Super Torque

Low Speed Dental Handpiece

Straight

Contra Angle

Air Motor



Light Cure Unit (Cordless)

Allure

A wide range of Dental Equipment

1 Sec Light Cure Unit



3 working modes :

M1 : Light intensity :
2300-2700mW/cm²
Time for choices :
1s,3s,5s

M2 : Light intensity :
1700-1900mW/cm²
Time for choices :
5s,10s,15s,20s

M3 : Light intensity :
1300mW/cm²
Time for choices :
5s,10s,15s,20s,
25s,30s,35s,40s,
45s,50s,55s,60s



Multi-Function Light Cure Unit



Working modes :

2 Modes available in LED

1. High Curing Mode
2300-2500 mw/cm²
• 1 Second
• 3 Second

2. Normal Mode
1000-1200 mw/cm²
• 5 Second
• 10 Second
• 15 Second
• 20 Second



Composite Heater



Range 40°C TO 70°C

STANDBY MODE

HEATING MODE

MODE SETTING



• Can also heat Sodium Hypochlorite in syringe





DIAMOND BURS FG





A BRAZILIAN BRAND
 CREATING SMILES
 WORLDWIDE.













QUALITY APPROVED
 BY DENTISTS IN **+ 95 COUNTRIES**



											
TF-11 ISO 173/014	TF-12 ISO 173/015	TF-13 ISO 173/018	TF-14 ISO 172/022	TF-20 ISO 171/014	TF-21 ISO 171/016	TR-11 ISO 199/015	TR-12 ISO 199/016	TR-14 ISO 198/022	TR-19 ISO 200/018	TR-20 ISO 197/014	TR-21 ISO 197/016
TF SERIES						TR SERIES					

										
TR-25 ISO 198/025	TR-26 ISO 198/018	TC-11 ISO 299/016	TC-21 ISO 298/014	TC-26 ISO 164/011	FO-11 ISO 299/012	FO-21 ISO 297/014	FO-22 ISO 298/016	FO-25 ISO 243/028	FO-27 ISO 243/032	FO-32 ISO 243/018
TC SERIES					FO SERIES					

									
SF-11 ISO 111/012	SF-12 ISO 111/014	SF-13 ISO 111/016	SF-21 ISO 110/014	SF-31 ISO 109/013	SF-41 ISO 109/010	SO-20 ISO 288/012	SO-21 ISO 289/014	SR-11 ISO 141/012	SR-12 ISO 141/014
SF SERIES			SO SERIES			SR SERIES			

*Dimensions of the product may vary from the image representation



EX-11
ISO 039/032

EX-20
ISO 237/018

EX-21
ISO 237/021

EX-24
ISO 220/018

EX-26
ISO 237/032

BR-31
ISO 001/018

BR-40
ISO 001/016

BR-41
ISO 001/014

BR-45
ISO 001/010

BR-46
ISO 001/012

BR-49
ISO 001/007

EX SERIES

BR SERIES



DI-41
ISO 019/010

DI-42
ISO 019/013

SI-46
ISO 010/012

SI-47
ISO 010/014

SI-48
ISO 010/017

RS-11
ISO 199/018

RS-21
ISO 197/018

WR-13
ISO 068/041

TC-S21
ISO 298/014

TF-S21
ISO 171/016

TR-S13
ISO 198/018

TR-S21
ISO 197/016

TR-SS21
ISO 197/016

DI SERIES

SI SERIES

RS SERIES

WR SERIES

S SERIES

SS SERIES



BR-31C
ISO 001/018

FO-32C
ISO 243/018

FO-54C
ISO 190/018

SF-12C
ISO 111/014

TC-11C
ISO 299/016

TF-13C
ISO 173/018

TR-13C
ISO 198/018

TR-62C
ISO 198/021

WR-13C
ISO 068/041

C SERIES



CR-11EF
ISO 856/025

EX-21EF
ISO 237/021

TC-11EF
ISO 299/016

TC-21EF
ISO 298/014

TF-12EF
ISO 173/015

TF-21EF
ISO 171/016

TR-11EF
ISO 199/015

TR-13EF
ISO 198/018

TR-21EF
ISO 197/016

TR-S21EF
ISO 197/016

TR-25EF
ISO 198/025

TR-26EF
ISO 199/018

EF SERIES

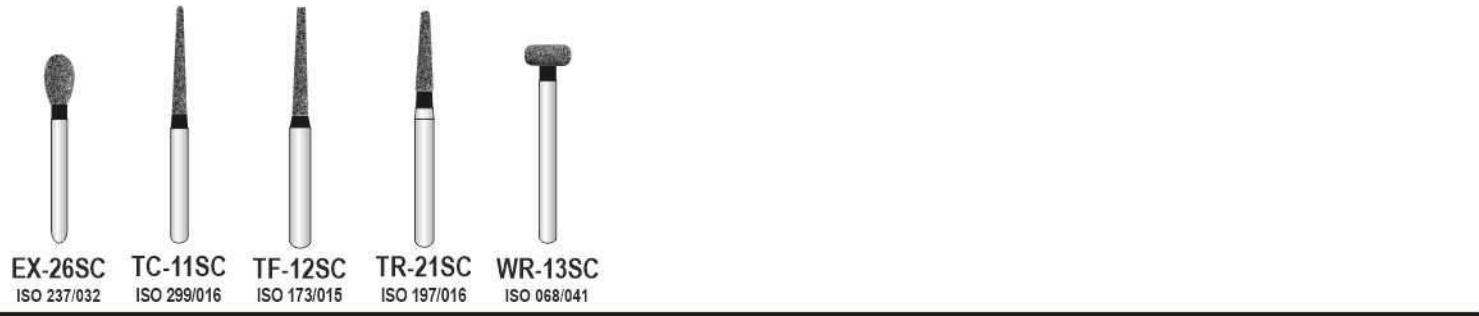

EX-26SC
ISO 237/032

TC-11SC
ISO 299/016

TF-12SC
ISO 173/015

TR-21SC
ISO 197/016

WR-13SC
ISO 068/041

SC SERIES

*Dimensions of the product may vary from the image representation

Dentaport ZX

Apex Locator

Reliable apex localization



Tri Auto Mini

Endo Motor

Compatible with RZM

Compact, cordless endodontic handpiece

9mm only

Automatic Controls (when connected to Root ZX mini)

- Canal Measurement Meter Display
- Auto Apical Stop or Reverse
- Auto Start and Stop
- Auto Apical Slow-down
- Auto Apical Torque Reduction

weight
100g
including
contra angle &
lithium batteries

Root ZX Mini

Apex Locator

Compatible with TAM

Measures root canals accurately & precisely



Combo Offer

Root ZX mini
+
Tri Auto mini
+
Accessories

- Transmission Cable
- File Electrode



Safety functions prevent
over - preparation,
misalignment of files & injuries



MADE IN JAPAN

Beyond Ingenuity - Intelligent Endodontic Motor

Tri Auto ZX2+

Cordless Endo Motor with built-in Apex Locator

- Next Level Reciprocation - Introducing OGP2
- The Efficiency of OTR
- World-leading apex location Built Right in
- Various Modes

**Patency and Glide Path
Have Never Been Easier**

Various Modes

EMR

for Apex Location

CONT CW

Motor rotates continuously clock-wise

CONT CCW

Motor rotates continuously counter clock-wise

OGP

Optimum Glide Path

OGP 2

Optimum Glide Path 2

OTR

Optimum Torque Reverse

weight
140g

including
contra angle &
lithium batteries

Upper Part Enlargement

Patency

**Apex Location & Determining
Working Length**

Glide Path

Shaping



OGP Mode

OGP (Optimum Glide Path) Function

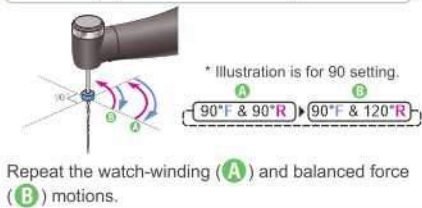

OGP2 Mode

OGP2 (Optimum Glide Path 2) Function

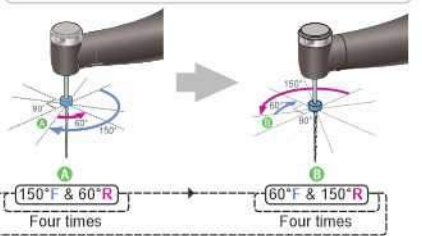

OTR Mode

OTR (Optimum Torque Reverse) Function

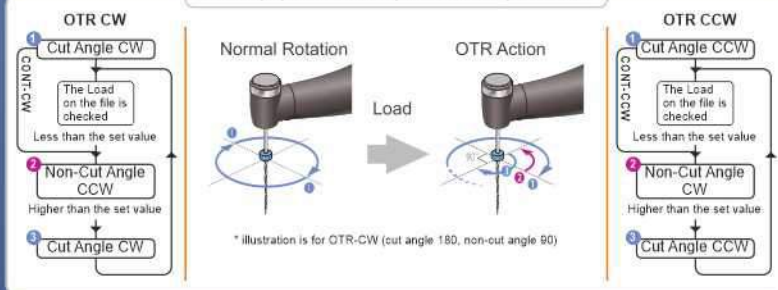

Quick Guide Videos



Before Use & Reprocessing



Basic Usage



Advanced Usage

MADE IN JAPAN



Features

*The chair image is illustrative; actual items included will be as per your quotation.

- Programmable Dental Chair Unit with 3 Variable Programs,
3 Fixed Programs - Z (Zero); G (Gargle); E (ER Working Position)
- LED X-Ray viewer, Pressure gauge
- 2 High-speed Airtor connections & 2 Three-way syringe
- **In-built E-Type Micro Motor Kit with Engine**
- **In-built LED Scaler with 5 Tips**
- Pneumatic lock for control box arm
- Large instrument base on control box
- LED (6 LED) Light multi-intensity with sensor
- 2 Arm rest
- Joystick foot control on the base of the unit
- Master foot control with S (Spittoon)/T (Tumbler) switch
- Glass spittoon with definable timer control water filling system
- Assistant's side control 3-way syringe; Low & High venture suction
- Broad base for better stability
- Doctor's stool
- Emergency Stop switch on control box
- Cup mounted on control box to collect the waste during treatment



C-1



C-2



C-4



C-5



C-6



C-7



C-8



180°
Detachable Glass Spittoon



90°
Movable Side Unit



Assistant's side controls



Features

*The chair image is illustrative; actual items included will be as per your quotation.

- Programmable Dental Chair Unit with 2 Customised Programs, Last position/Gargle & Zero are Fixed Programs,
- Timer customizable for Cup Filler (Warm Water option) and Bowl Rinse
- 7" LED X-Ray film viewer ● Pressure gauge
- High-speed airtor connections x 2, three-way syringe x 1
- **In-Built Woodpecker LED Scaler With 5 tips**
- Touch Panel ● Pneumatic lock for control box arm
- Movable arm rest for easy entry / exit for patients
- LED Reflection type Dental Light with sensor (Luminance up to 30,000 Lux at Standard Mode) (Luminance up to 20,000 Lux at Yellow Mode)
- Multi functional foot control
- Detachable frosted Glass Spittoon with 180 deg swivel
- Master Switch for Power / Water & Air On / Off
- Emergency Stop Switch
- **Assistant's side controls:**
Chair movement control, Light On / Off, Cup Filler, Bowl Rinse, Last position/Gargle, Zero, M1, M2, Three-way syringe x 1, HVE x 1, Saliva ejector x 1, Instrument tray
- **In-Built Woodpecker LED Light Cure Unit**
- Compact side unit with 90 deg swivel
- Distilled water bottle x 1 (Also for tap water), Disinfection bottle x 1

Optional

- In-Built Micro Motor Kit With Engine

Touch Panel

Doctor's Stool

- **Relax Position**
Adjustable Backrest Height & Recline
- **Consulting Position**
For comfortable posture
- **Operational Position**
Adjust the backrest and the seat-rest at incline angle

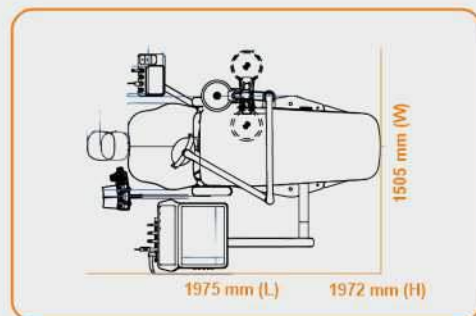

PVC - 1



PVC - 2



PVC - 3



PVC - 4



PVC - 7



PVC - 12



Detachable Ceramic Spittoon



Movable Side Unit



Assistant's side controls



Features

*The chair image is illustrative; actual items included will be as per your quotation.

- Programmable Dental Chair Unit with 9 Customised Programs (3 Users x 3 Programs),
Fixed Programs: Last position/Gargle, Zero, Spittoon Clean & Trendelenburg Position (Shock Position)
- Timer customizable for Cup Filler (Warm Water option) and Bowl Rinse
- 7" LED X-Ray film viewer ● **Digital Pressure gauge**
- High-speed airtor connections x 3, Three-way syringe x 1
- **In-Built Woodpecker LED Scaler With 5 tips**
- LCD Display Touch Screen ● Touch lock for control box arm
- Movable arm rest for easy entry / exit for patients
- LED Reflection type Dental Light with sensor
(Luminance up to 30,000 Lux at Standard Mode)
(Luminance up to 20,000 Lux at Yellow Mode)
- Multi functional foot control
- Detachable Ceramic Spittoon with 180 deg swivel
- Master Switch for Power / Water & Air On / Off
- Emergency Stop Switch
- **Assistant's side controls:**
Chair movement control, Light On / Off, Cup Filler, Bowl Rinse,
Last position/Gargle, Zero, M1, M2, Three-way syringe x 1, HVE x 1,
Saliva ejector x 1, Instrument tray
- **In-Built Woodpecker LED Light Cure Unit**
- Compact side unit with 90 deg swivel
- Distilled water bottle x 1 (Also for tap water), Disinfection bottle x 1

LCD Display Touch Screen

Doctor's Stool

- **Relax Position**
Adjustable Backrest Height & Recline
- **Consulting Position**
For comfortable posture
- **Operational Position**
Adjust the backrest and the seat-rest at incline angle

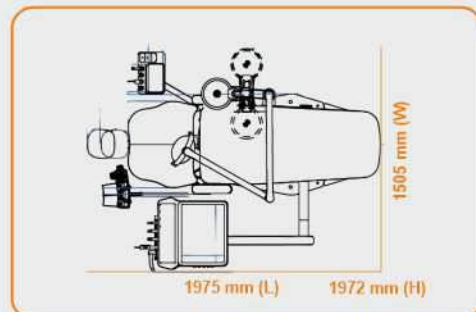

PVC - 1



PVC - 2



PVC - 3



PVC - 4



PVC - 7



PVC - 12

External Oral Suction ES 500



With
Wireless Remote

High-end
Touch Panel



ES 500 has a 4 layer filtration & 1 UVC lamp

- 1 layer of washable cotton filter
- 1 layer of water vapor absorbing filter
- 1 layer of H13 HEPA
- 1 layer of active carbon filter

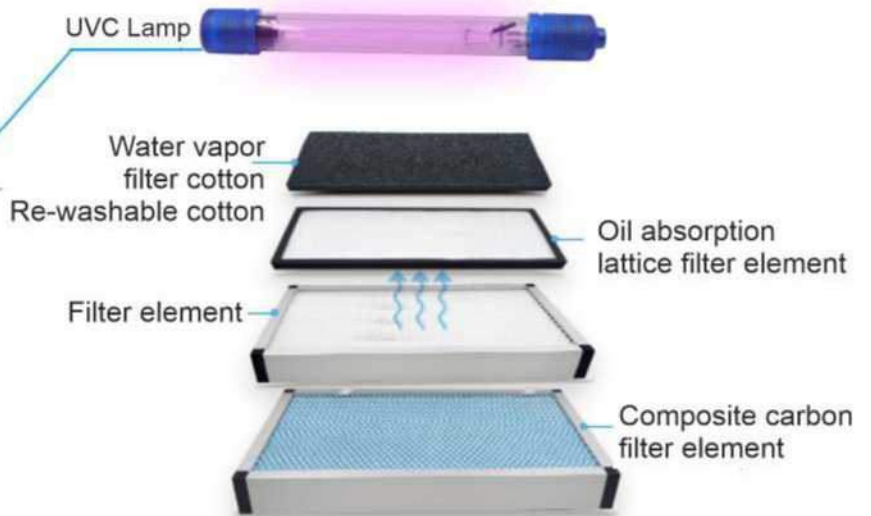

Voltage:
110V 60hz/220V 60hz
Noise: 30-40db

N.W: 18.6kg
Size: 50x33x53cm

Air Flow Rate: 310m³/h
Negative Pressure: 3.2kpa
Filtration: 0.3 u m 99.96%

External Oral Suction ES 1000

**Greatly reduces the risk of cross infection
between doctors & patients
& protects respiratory health**



Voltage/Frequency:
110V-240V, 50HV/60HV

Rated power:
1000 W

Control mode:
Touch screen /
two gears adjustable

Suction flow:
4000L/min

Filtration efficiency:
99.9%

Noise:
≤ 60db

Product Size:
32x33x75.5cm
Arm Length 1.3m

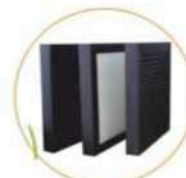

Efficient Filtration



Segmented Rotary Arm



High-end Touch Panel

-Power suction motor (Keeps strong suction)

-Double activated carbon + HEPA high precision filter (4 quadruple filtering)

-UVC Irradiation + Plasma sterilization

-Easily solves harmful substances such as air-liquid droplets, aerosols, cutting dust & odors in clinic



PRIME Saliva Ejectors

- Vented - Bonded - Flexible Tips
- Soft cushioned vinly tips
- Easily Shaped
- Wire re-inforced
- Non Toxic

100 pcs

Transparent / Clear tip
Disposable / Single use

India's First Integrated Nitrile Gloves

**Nitrile Examination
Gloves** Powder-Free
Disposable | Non- Sterile



 **1st
Love**



Sizes :

XS / S / M / L (100 Pcs / Box)

PRIME Gloves



Natural Color

Finger Textured
Powdered

Available in sizes
Large (100 Pcs / Box)

Latex



PRIME Mask



Disposable & Non Sterile Face Mask

- Non-woven
- Non Irritating
- Water repellent
- Ultrasonic sealing
- Resistance to airborne particles
- Colors : Blue • Type : 3 ply
- Quantity : Elastic 100 Pcs / Box

Face Shield

Effectively protecting faces
Efficiently isolating viruses

- Safe
- Clear vision
- Light & Easy
- Skin-Friendly
- Soft material
- Ergonomics design
- Comfortable to wear
- Double-sided
Antifogging

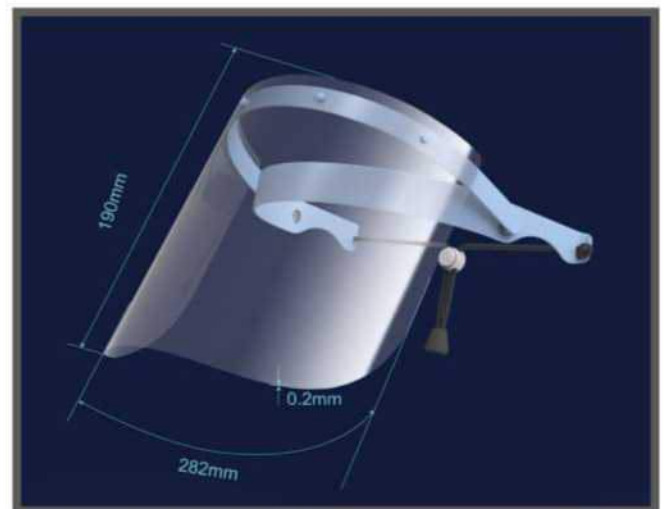

Anti-Dust



Anti-Droplets



Detachable
Shield



Anti-Splash



Anti-Fog



PRIME[®]

DENTAL PRODUCTS PVT LTD

Established in 1987

Manufacturer & Importer of Dental Materials & Equipment



MFG/MD/2023/000109
MFG/MD/2023/000100

Imported / Marketed



Prime Dental Products Pvt Ltd

Plot No. A-148, Road No. 24, MIDC, Wagle Industrial Estate, Thane (West)-400604, Maharashtra, India.

+91 9272235922

info@prime-dental.in

www.primedental.in